

Optical Metrology

Lecture 4: Methods in Surface Measurement

Outline

- Conventional surface measurement methods
- Stylus based methods
- Non-optical methods
 - Scanning electron microscopy
 - Atomic force microscopy
 - Scanning capacitance microscopy
- Optical methods
 - Microscopy
 - Focus sensing systems
 - Interferometry

What is surface measurement?

- Often product quality is associated with surface roughness.
- A smooth surface is usually more expensive to make.
- The machining process will determine the roughness.
- Very few surfaces are completely smooth.
- On a microscopic level most surfaces exhibit waviness and roughness
- Measurements of surface profiles are carried out to better visualize the surface, and to quantify roughness.
- Statistical formulae are applied to the data collected and standard measures are obtained.

Examples of surfaces

- Telescope Mirror
 - Primary property: Has to be reflective!
 - “Rest of material” - support and shape.



Examples of surfaces

- Brake pad
 - Primary properties: high friction and low wear over wide temperature range
 - Secondary properties: right shape.



Examples of surfaces

- Machinetools
 - Primary Property: high hardness and abrasion and oxidation resistance.
- Secondary properties: right shape.



Examples of surfaces

- Semiconductor substrates
 - Absolute smoothness and freedom from defects
 - Strength, etc. Substrate may need different electrical properties.

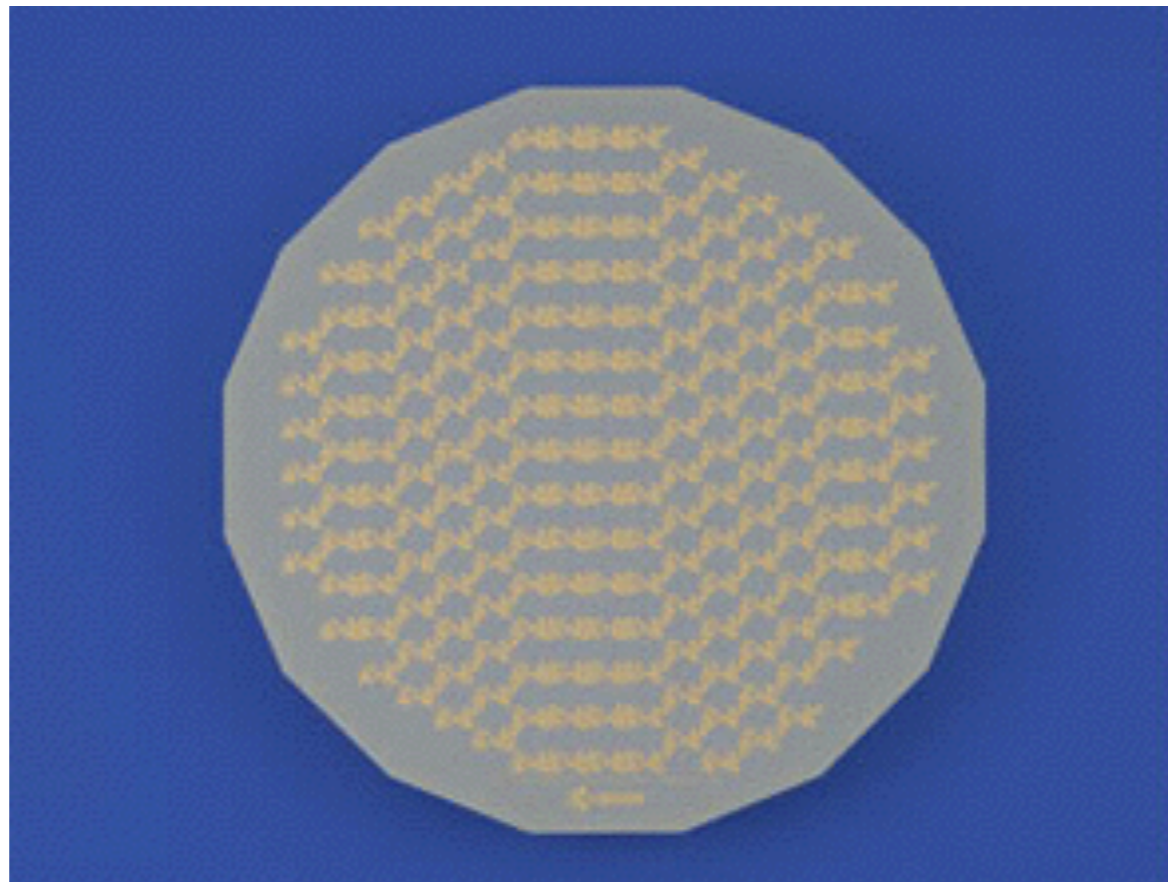

Surface vs. Cost

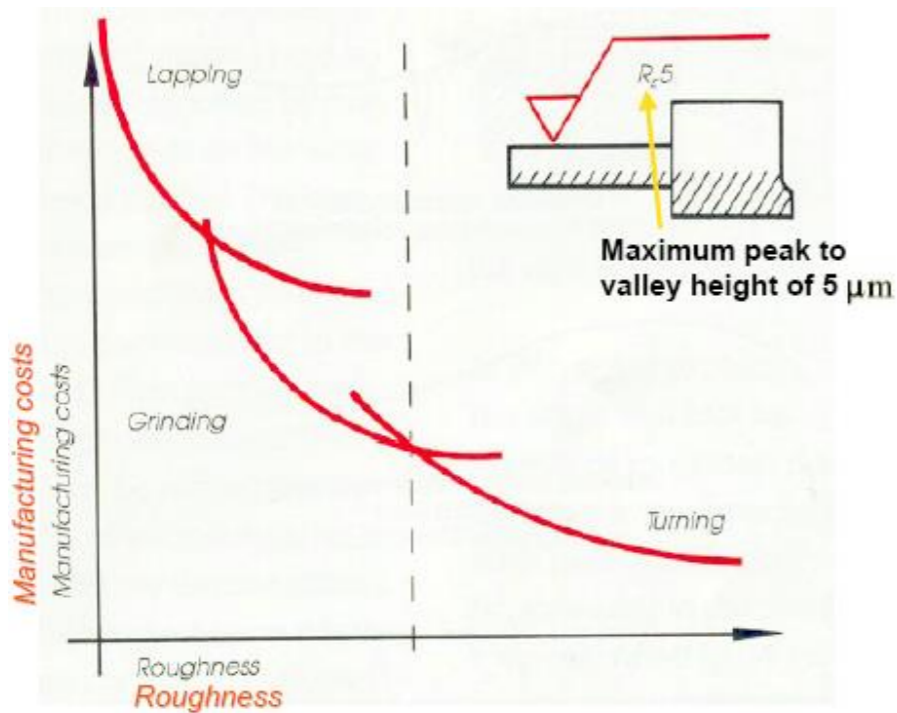

	Ra μm	50	25	12.5	6.3	3.2	1.6	.8	.4	.2	.1	.05	.025	.012	
	Ra μin	2000	1000	500	250	125	63	32	16	8	4	2	1	.5	
METAL CUTTING															
sawing		█	█	█	█	█	█	█	█	█	█	█	█	█	█
planing, shaping		█	█	█	█	█	█	█	█	█	█	█	█	█	█
drilling		█	█	█	█	█	█	█	█	█	█	█	█	█	█
milling		█	█	█	█	█	█	█	█	█	█	█	█	█	█
boring, turning		█	█	█	█	█	█	█	█	█	█	█	█	█	█
broaching		█	█	█	█	█	█	█	█	█	█	█	█	█	█
reaming		█	█	█	█	█	█	█	█	█	█	█	█	█	█
ABRASIVE															
grinding		█	█	█	█	█	█	█	█	█	█	█	█	█	█
barrel finishing		█	█	█	█	█	█	█	█	█	█	█	█	█	█
honing		█	█	█	█	█	█	█	█	█	█	█	█	█	█
electro-polishing		█	█	█	█	█	█	█	█	█	█	█	█	█	█
electrolytic grinding		█	█	█	█	█	█	█	█	█	█	█	█	█	█
polishing		█	█	█	█	█	█	█	█	█	█	█	█	█	█
lapping		█	█	█	█	█	█	█	█	█	█	█	█	█	█
superfinishing		█	█	█	█	█	█	█	█	█	█	█	█	█	█
CASTING															
sand casting		█	█	█	█	█	█	█	█	█	█	█	█	█	█
perm mold casting		█	█	█	█	█	█	█	█	█	█	█	█	█	█
investment casting		█	█	█	█	█	█	█	█	█	█	█	█	█	█
die casting		█	█	█	█	█	█	█	█	█	█	█	█	█	█
FORMING															
hot rolling		█	█	█	█	█	█	█	█	█	█	█	█	█	█
forging		█	█	█	█	█	█	█	█	█	█	█	█	█	█
extruding		█	█	█	█	█	█	█	█	█	█	█	█	█	█
cold rolling, drawing		█	█	█	█	█	█	█	█	█	█	█	█	█	█
roller burnishing		█	█	█	█	█	█	█	█	█	█	█	█	█	█
OTHER															
flame cutting		█	█	█	█	█	█	█	█	█	█	█	█	█	█
chemical milling		█	█	█	█	█	█	█	█	█	█	█	█	█	█
electron beam cutting		█	█	█	█	█	█	█	█	█	█	█	█	█	█
laser cutting		█	█	█	█	█	█	█	█	█	█	█	█	█	█
EDM		█	█	█	█	█	█	█	█	█	█	█	█	█	█

common █
less frequent █

A Real-Life Example

A practical example is as follows. An aircraft maker contracts with a vendor to make parts. A certain grade of steel is specified for the part because it is strong enough and hard enough for the part's function. The steel is machinable although not free-machining. The vendor decides to mill the parts. The milling can achieve the specified roughness (for example, $\leq 3.2 \mu\text{m}$) as long as the machinist uses premium-quality inserts in the end mill and replaces the inserts after every 20 parts (as opposed to cutting hundreds before changing the inserts).

There is no need to add a second operation (such as grinding or polishing) after the milling as long as the milling is done well enough (correct inserts, frequent-enough insert changes, and clean coolant). The inserts and coolant cost money, but the costs that grinding or polishing would incur (more time and additional materials) would cost even more than that. Obviating the second operation results in a lower unit cost and thus a lower price. The competition between vendors elevates such details from minor to crucial importance.

It was certainly possible to make the parts in a slightly less efficient way (two operations) for a slightly higher price; but only one vendor can get the contract, so the slight difference in efficiency is magnified by competition into the great difference between the prospering and shuttering of firms.

Surface topography

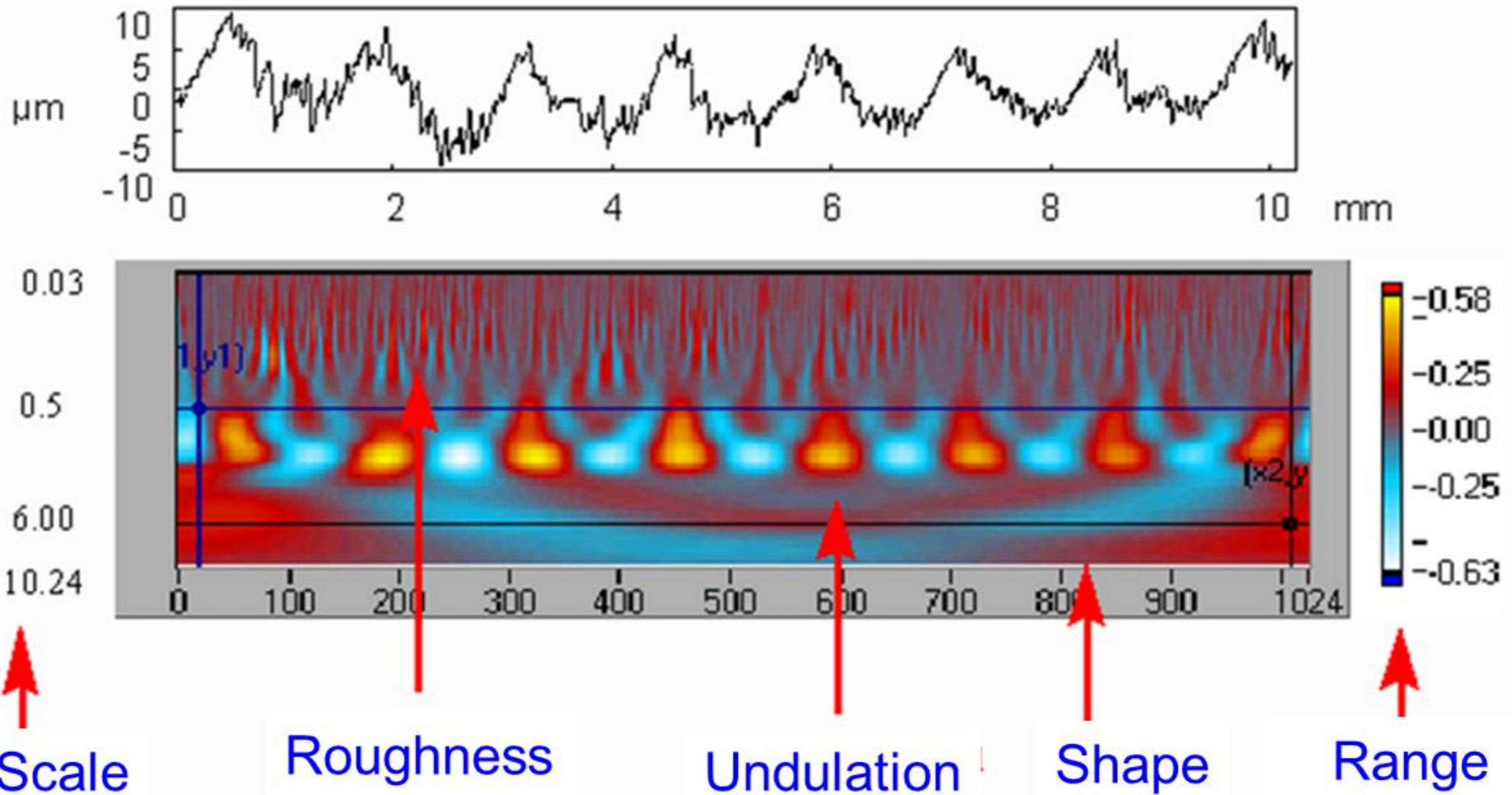

Surface topography

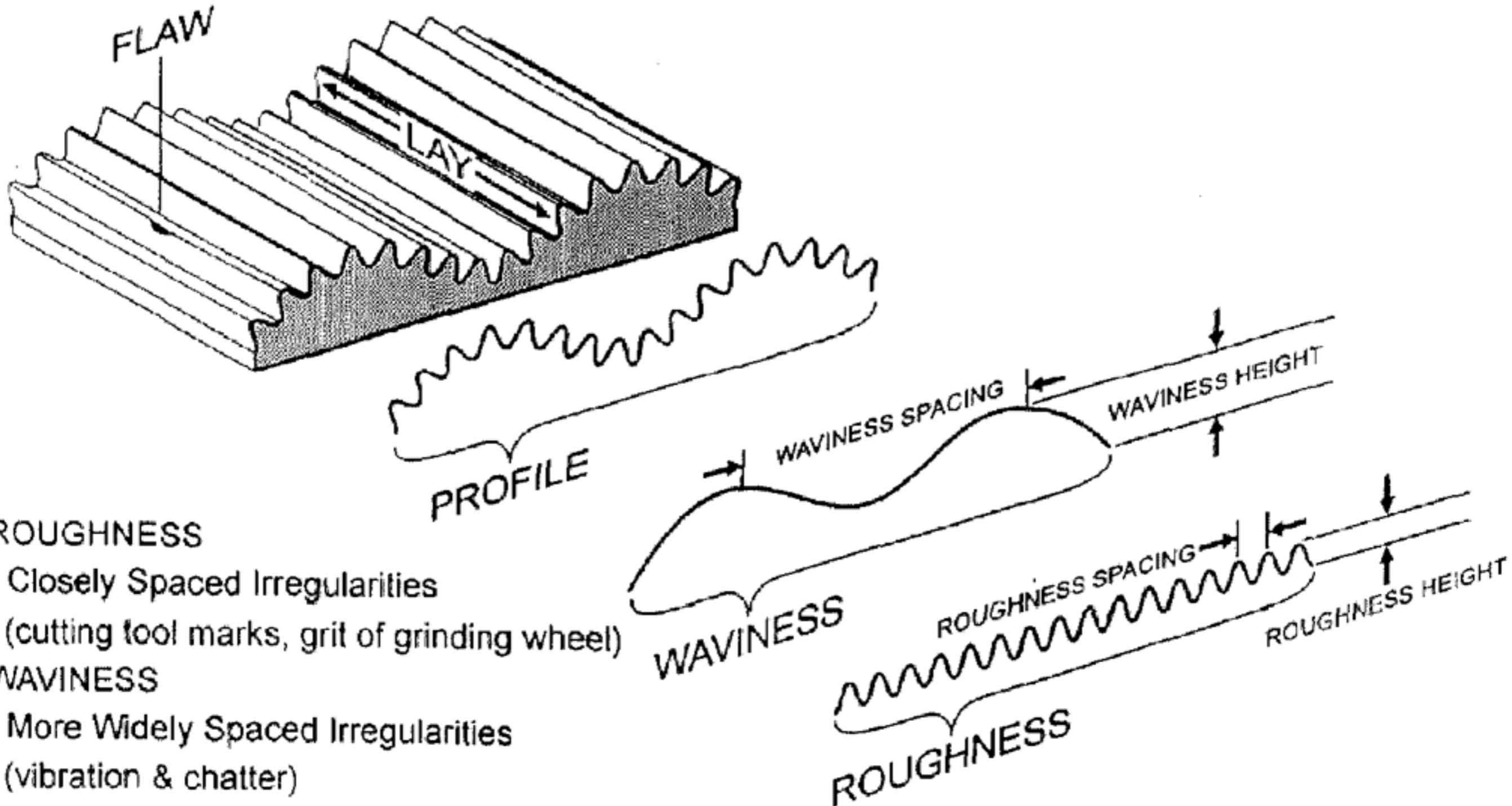

ROUGHNESS

- Closely Spaced Irregularities
(cutting tool marks, grit of grinding wheel)

WAVINESS

- More Widely Spaced Irregularities
(vibration & chatter)

END OF SLIDE

Surface topography

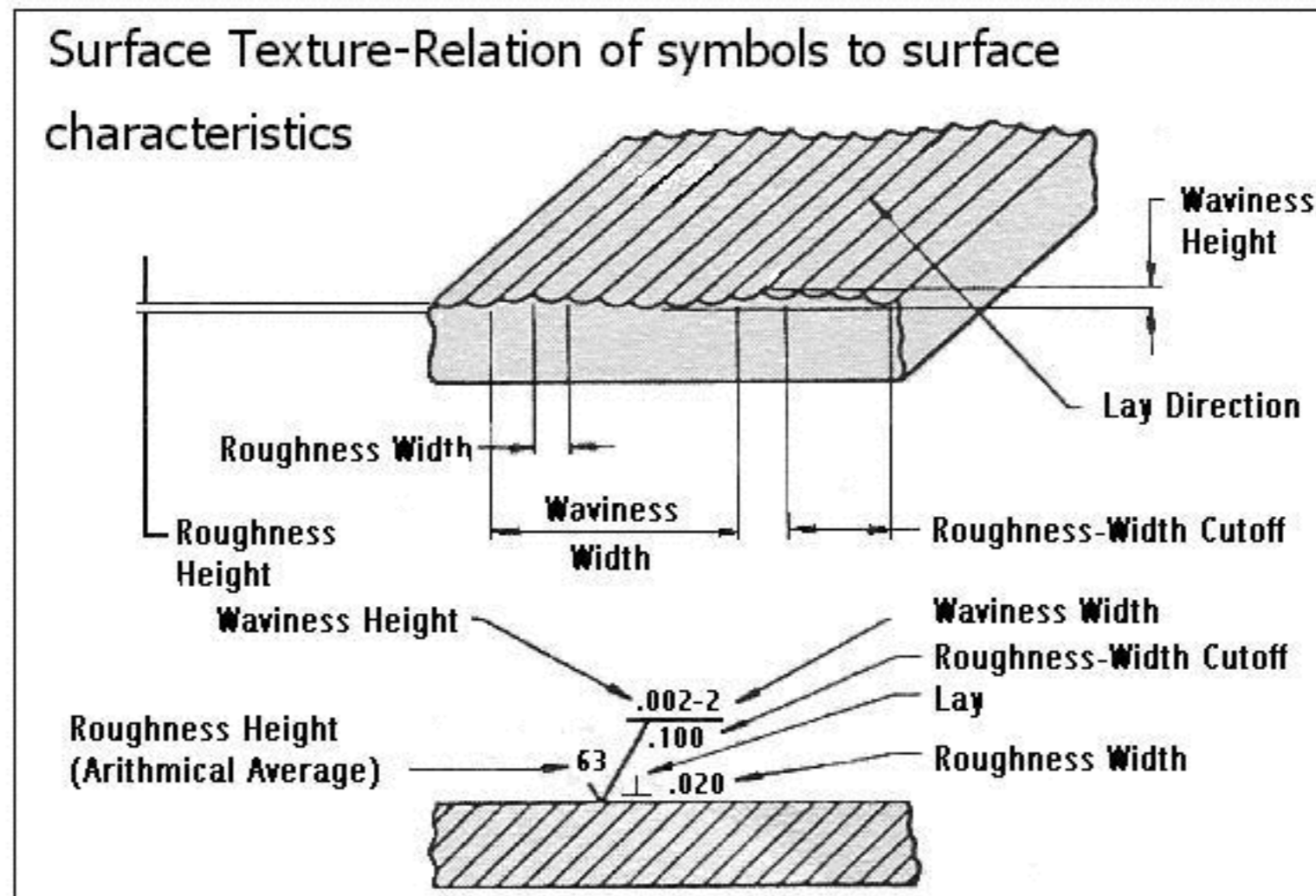

Surface topography

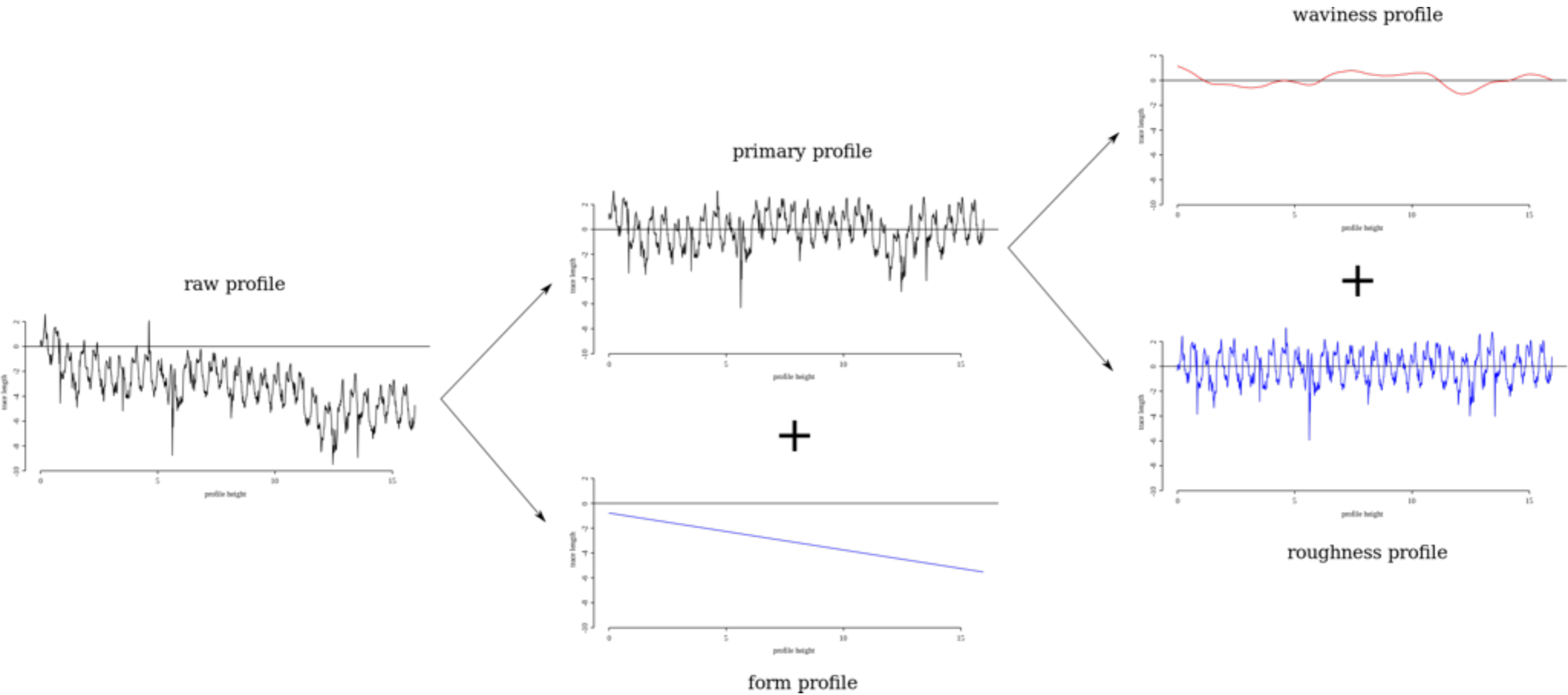

Measurement of Surface topography

- Commonest industrial (& lab) method is to use **stylus profilometry**
- Sharp point is dragged across surface, and up and down movement recorded
- Beware! Vertical and horizontal scales often very different - may be misleading

Real profile - 1:1

Vert/Horz - 15:1

Vert/Horz - 300:1

These are the same surface!

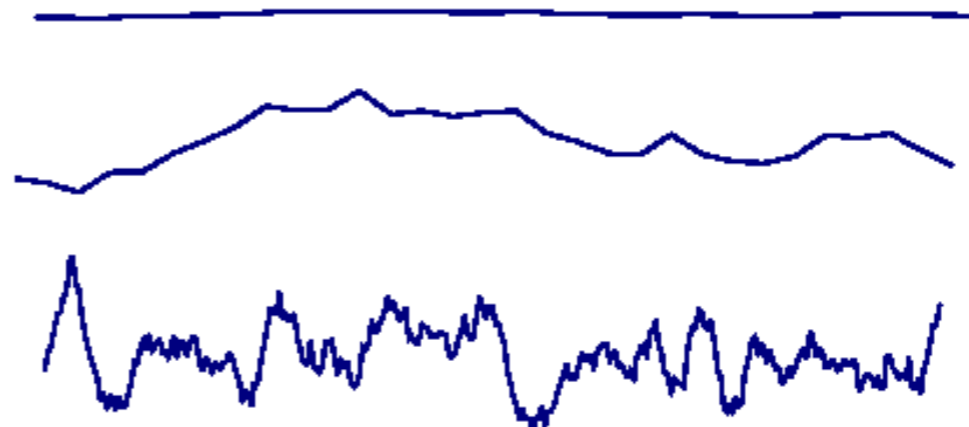

Measurement of Surface topography

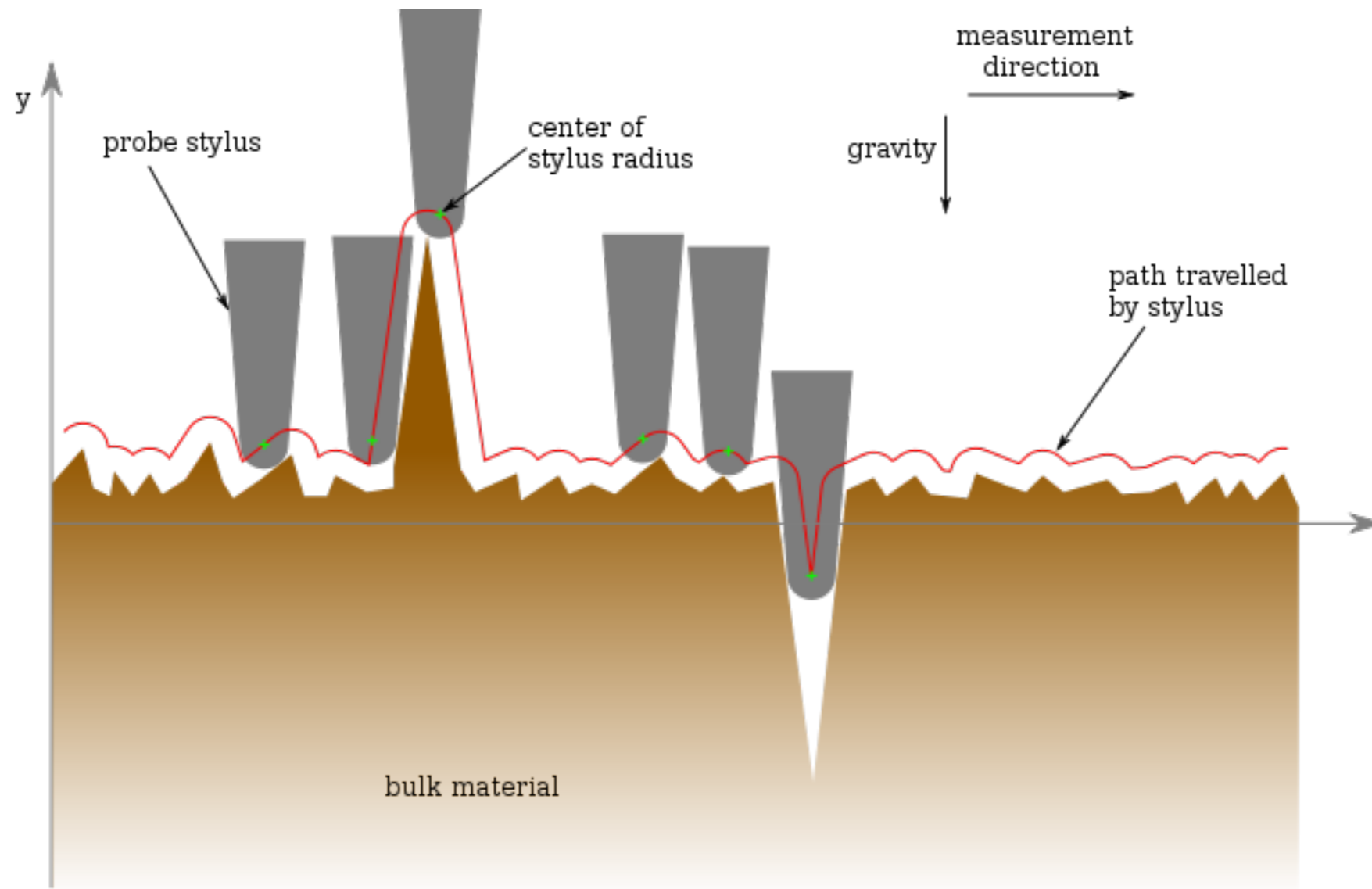

Profile parameters

- Average roughness R_a
 - Also called as CLA or AA
 - Arithmetic mean deviation of surface height from mean value. (Equal areas of profile above and below mean line)

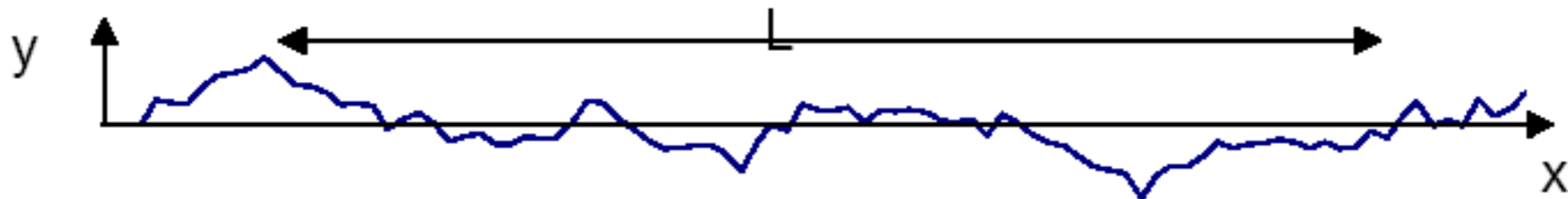

$$R_a = \frac{1}{L} \int_0^L |y(x)| dx$$

When evaluated from digital data, the integral is approximated by a trapezoidal rule

$$R_a = \frac{1}{N} \sum_{x=1}^N |y_x|$$

Initial Surface

- Take an arbitrary surface profile
 - We must first find the datum from which measurements are taken.

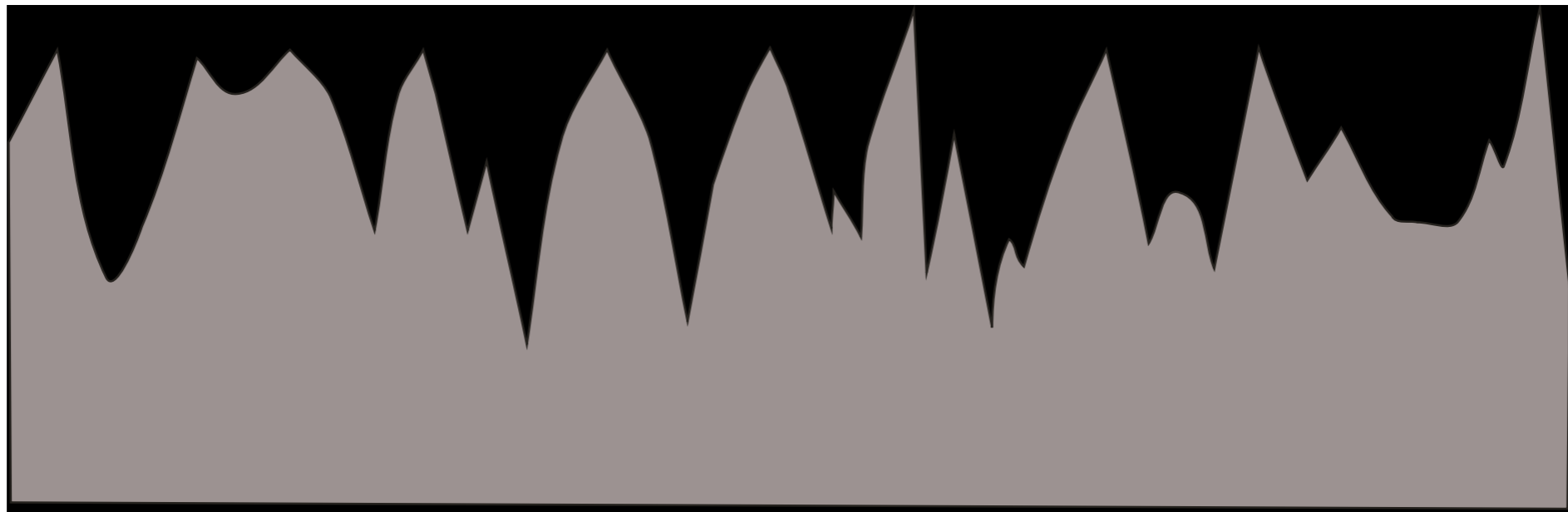

Establish the Datum Line

- The horizontal line is placed so that there is an equal area of color above and below it. This line is the datum from which measurements are taken.

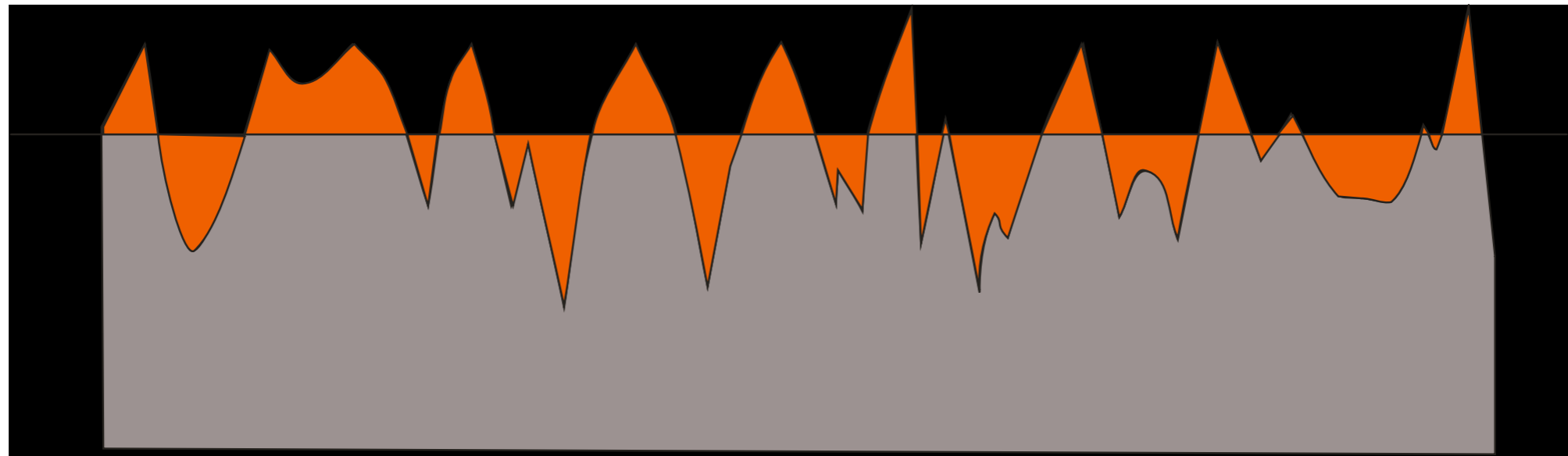

Add the Samples Together

- Divide the datum line into a number of sample points over the sample length.
- At each sample point draw a vertical line from the datum to the profile line.
- Add all these sample lengths together and divide by the number of samples.

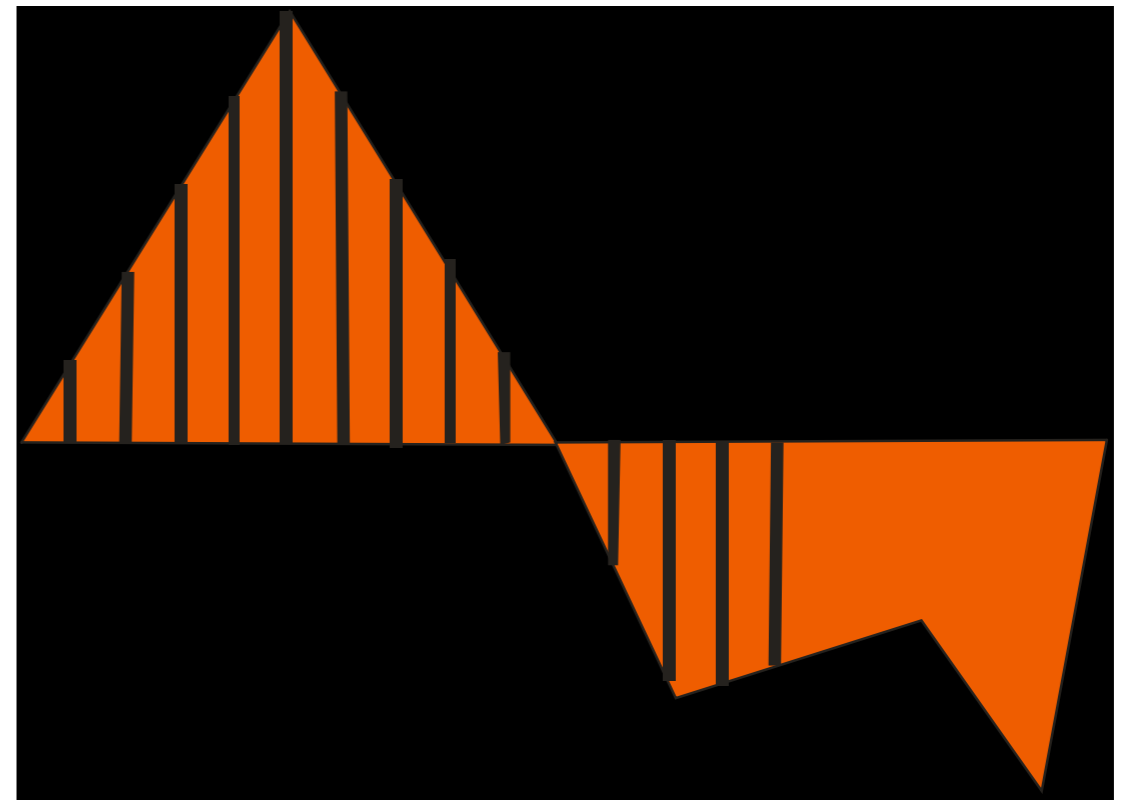

You Just Calculated the R_a

- The number you calculated is the R_a . It is the average distance the profile differs from the datum.
- Other names are Arithmetic Average (AA), Center Line Average (CLA) or Arithmetical Mean Deviation

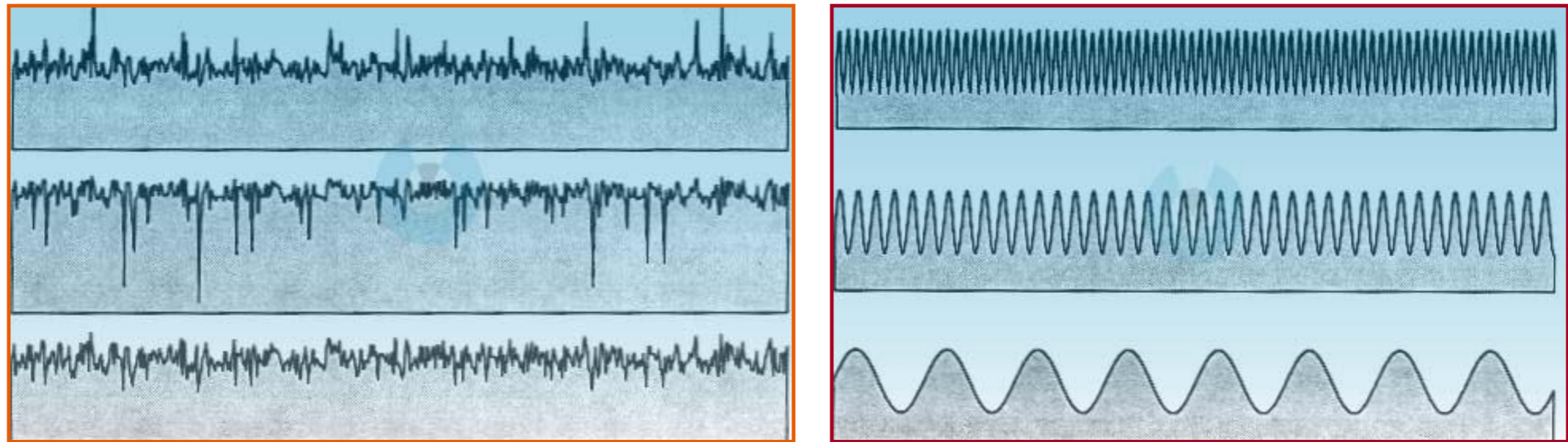

Even though the surfaces look different to the eye, these set of surfaces have same R_a .

R_a is Misleading

5.12 Micro Inches

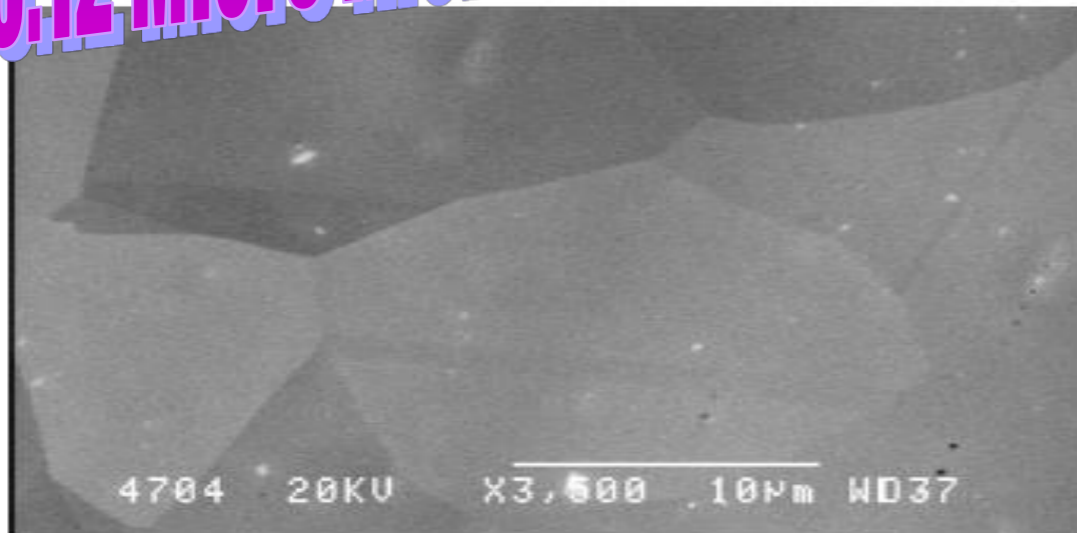

3500 x magnification

4.33 Micro Inches

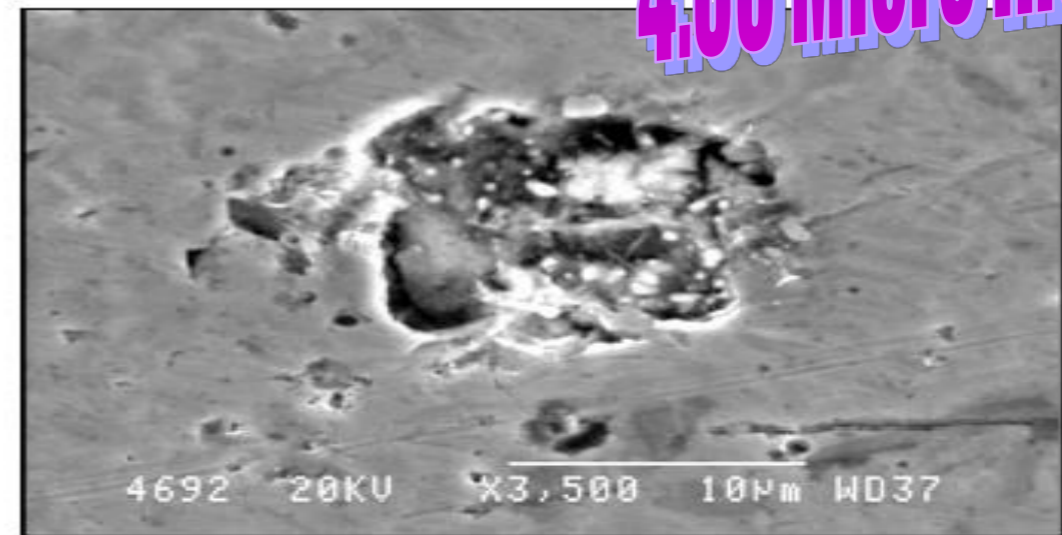

3500 x magnification

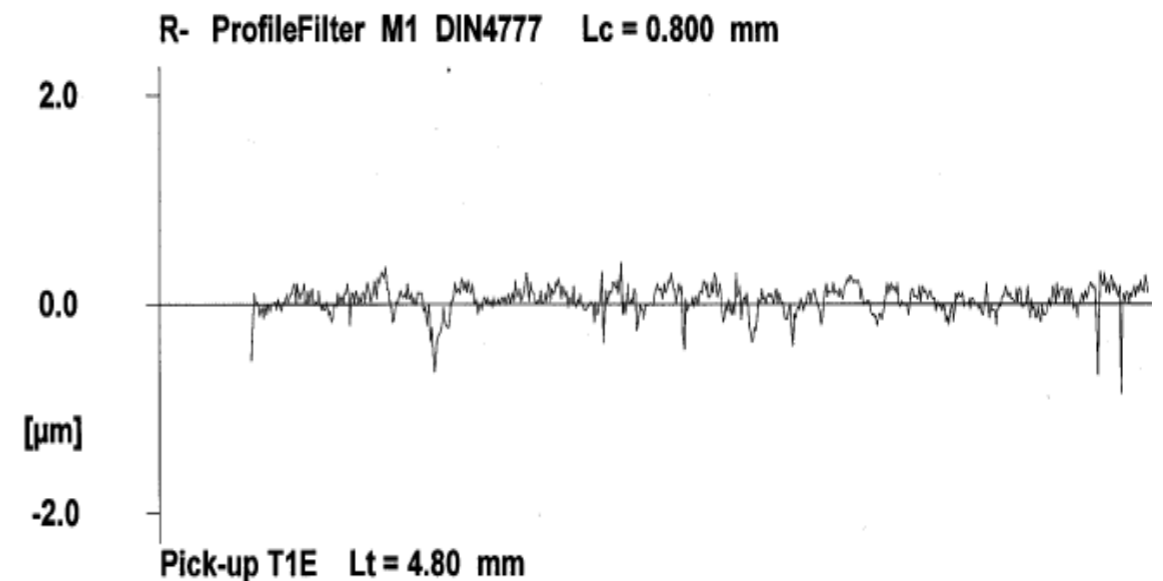
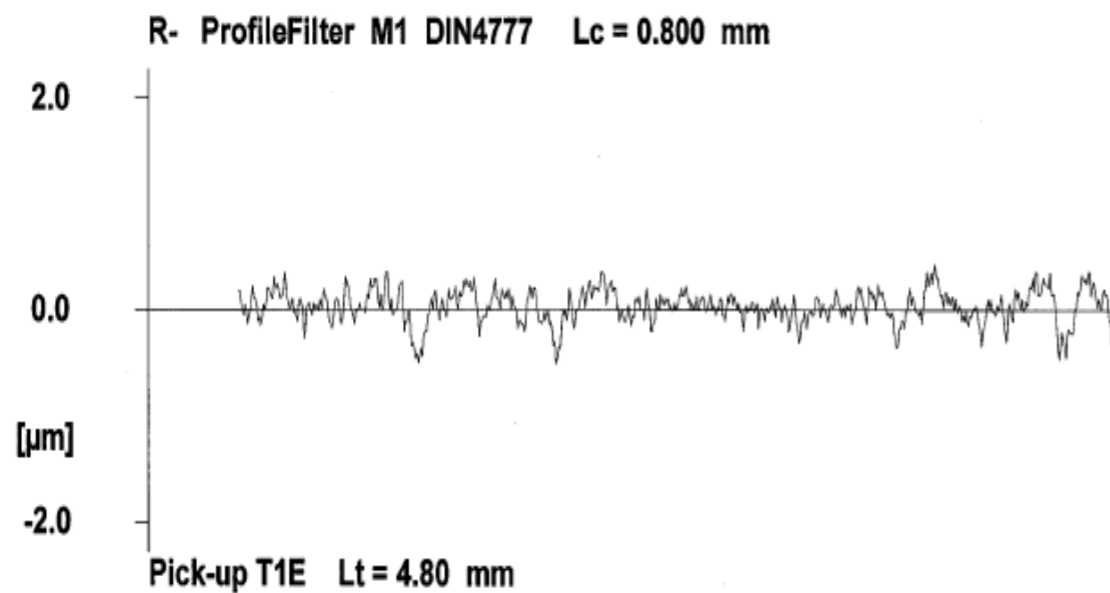

Profile parameters

RMS roughness R_q

- If surfaces differ in shape or spacing, we need to measure peaks and valleys and profile shape and spacing
- Square mean deviation of surface height from mean value.
- R_q has now superseded by R_a In metal machining specs.
- It is more directly related to the optical quality of a surface

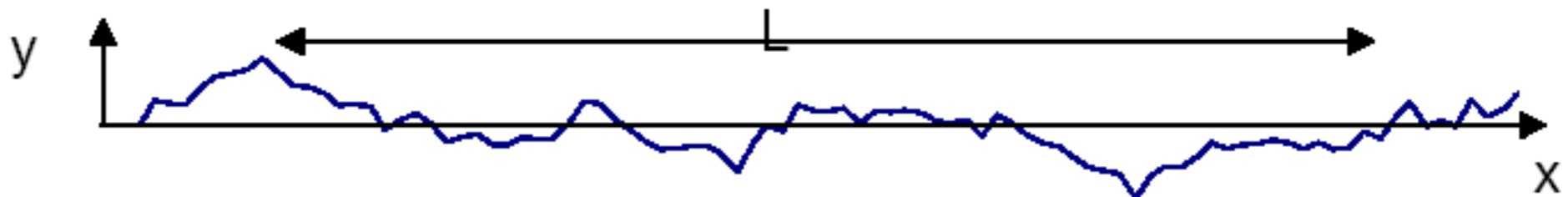

$$Rq = \sqrt{\frac{1}{N} \sum_{x=0}^N |(y_x)^2|}$$

Profile parameters

R_p R_v and R_t

- R_p is the height of the highest peak in the evaluation length.
- R_v is the height of the deepest valley in the evaluation length
- R_t is the sum of both heights **$R_p + R_v = R_t$**
- Used to find extreme cases:
 - A sharp spike or burr on the surface that would be detrimental to a seal.
 - A crack or scratch that might be indicative of poor material or processing.

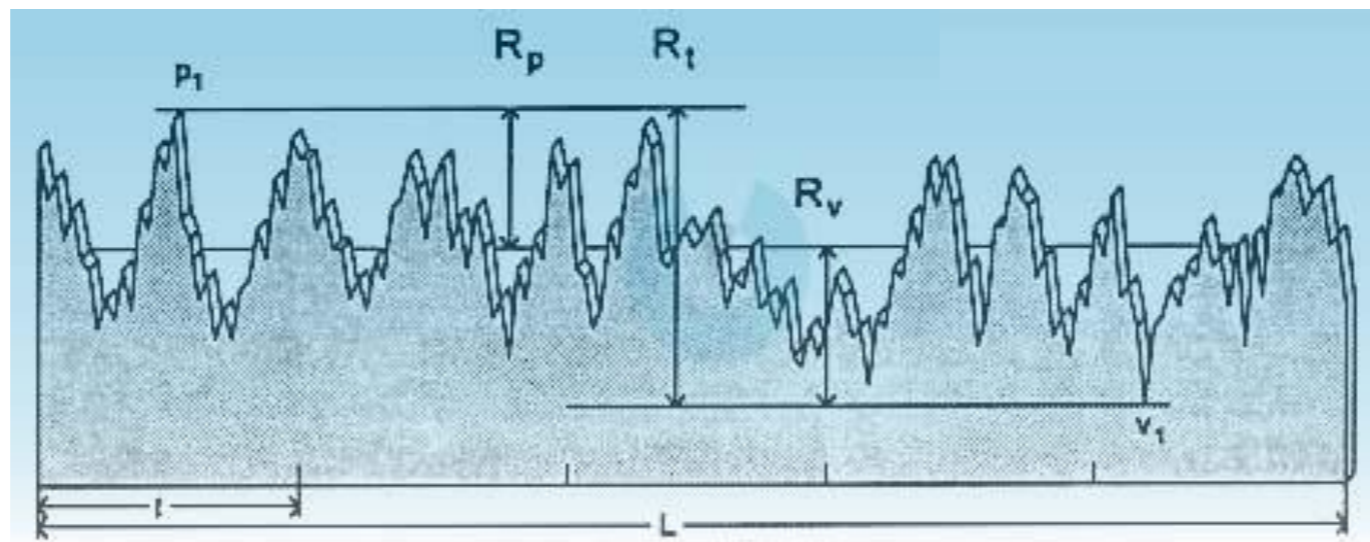

Profile parameters - Statistical

Amplitude Distribution Function (ADF)

- A surface could be characterized by a number.
- If few samples of measurements are taken on a surface, different numbers for R_a and R_q could be recorded
- R_a and R_q are widely used due to the great convenience, but they do not provide:
 - Any information about distribution of heights;
 - Any information about length scale in surface;
 - Any information about possible anisotropy.
- ADF is a probability function that gives the probability that a profile of the surface has a certain height, z , at any position x

Profile parameters - Statistical

Amplitude Distribution Function (ADF)

- The ADF has a bell shape like many probability distributions
- The ADF tells "how much" of the profile lies at a particular height
- It is the probability that a point on the profile at a randomly selected x value lies at a height within a small neighborhood of a particular value z :

$$\text{Prob}(z + dz > r(x) > z) = \text{ADF}(z) dz$$

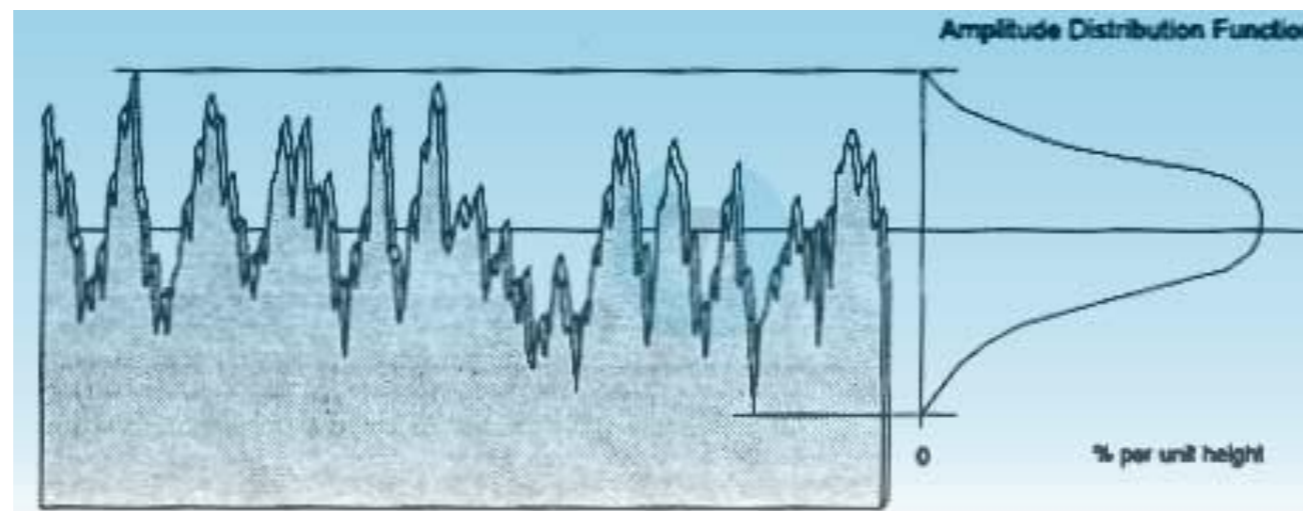

Profile parameters - Statistical

Bearing Ratio

- The Bearing Ratio Curve mathematically is the integral of ADF.
- It is the corresponding cumulative probability distribution.
- **It has much greater use in surface finish.**
- It shows what linear fraction of a profile lies above a certain height (compared to the ADF which tells how much of a surface lies at a given height).
 - Tells about shape, plateau, peaks, valleys.
 - Mathematically the bearing ratio curve can be calculated from ADF.
 - Or calculated directly from a profile.

Calculated from highest peak downward

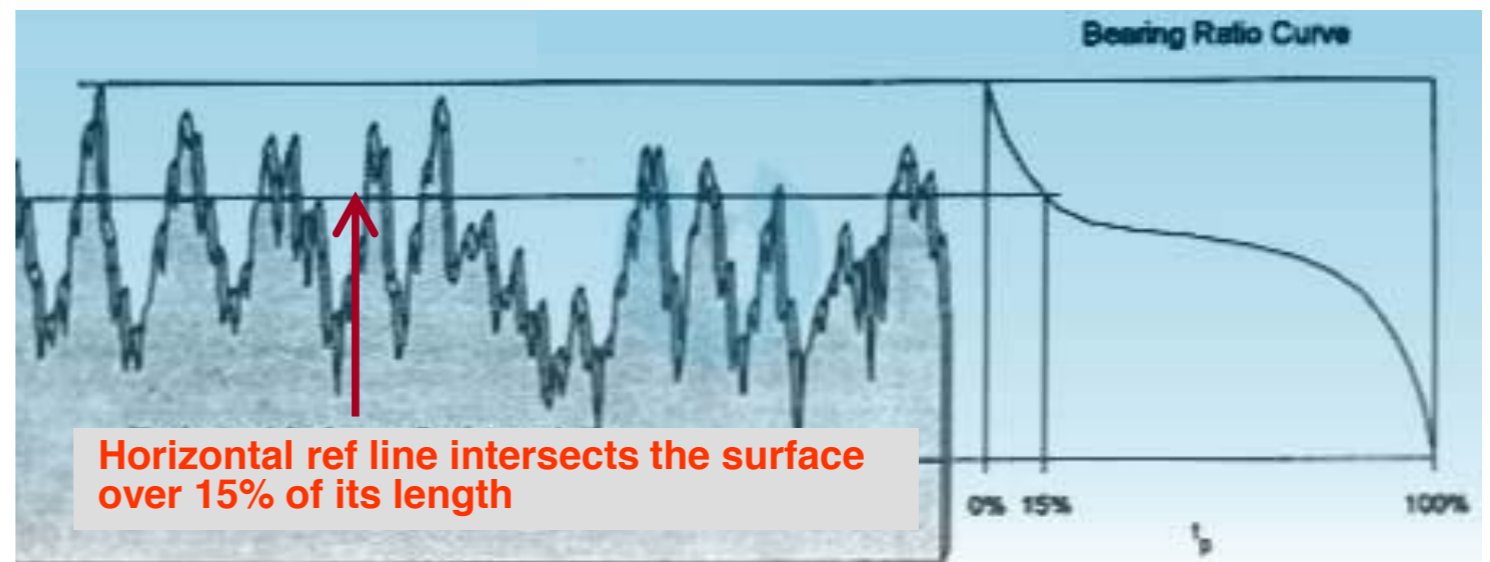

Profile parameters - Statistical

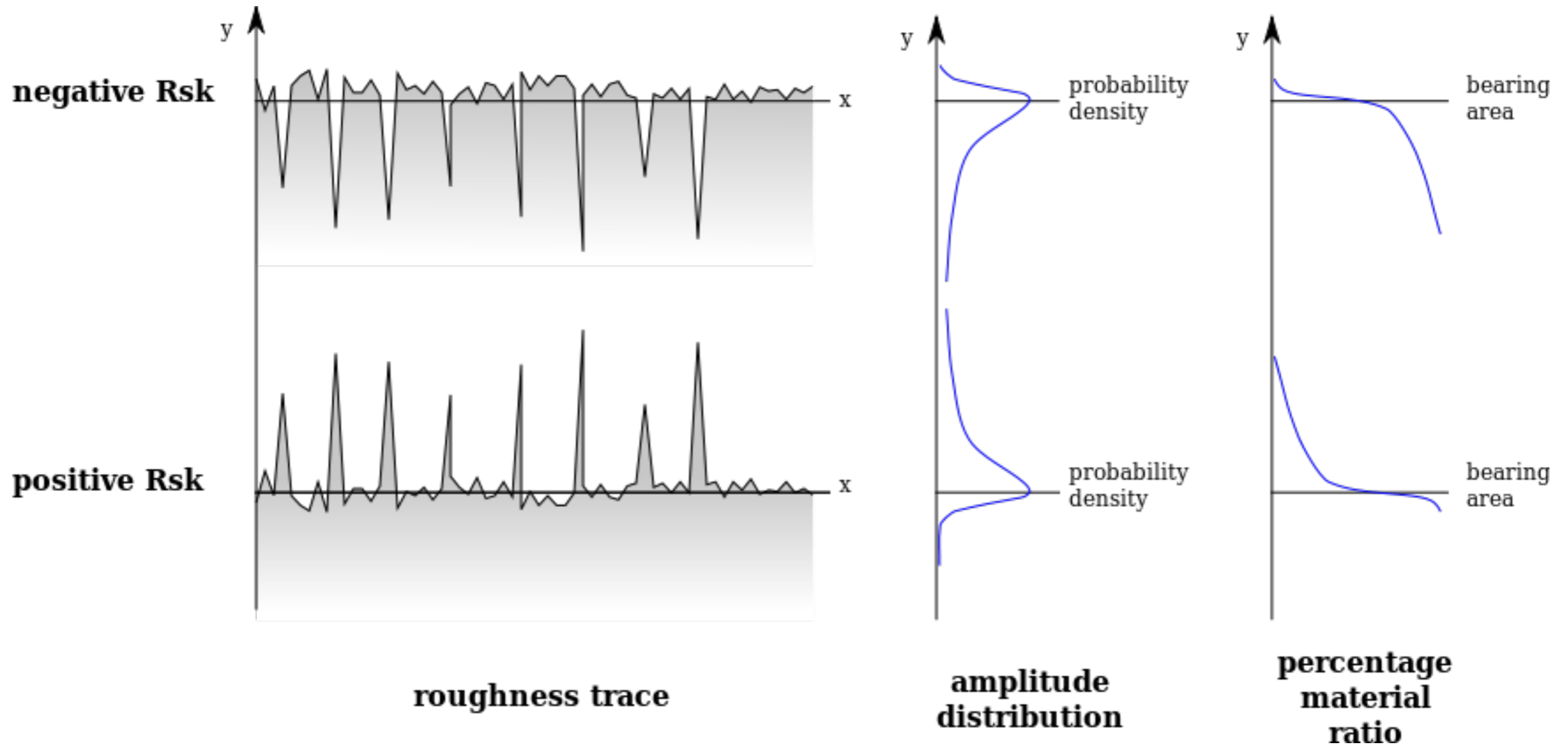

Profile parameters - Statistical

Skewness (third moment of ADF)

- Skewness is another parameter that describes shape of ADF.
- It is a measure of asymmetry of ADF (it is non dimensional).
- Positive skewness, (**turned surfaces**) have high spikes.
- Negative skewness, (**porous surfaces**) have deep valleys.
- More random (**e.g. ground**) surfaces have a skew near zero:

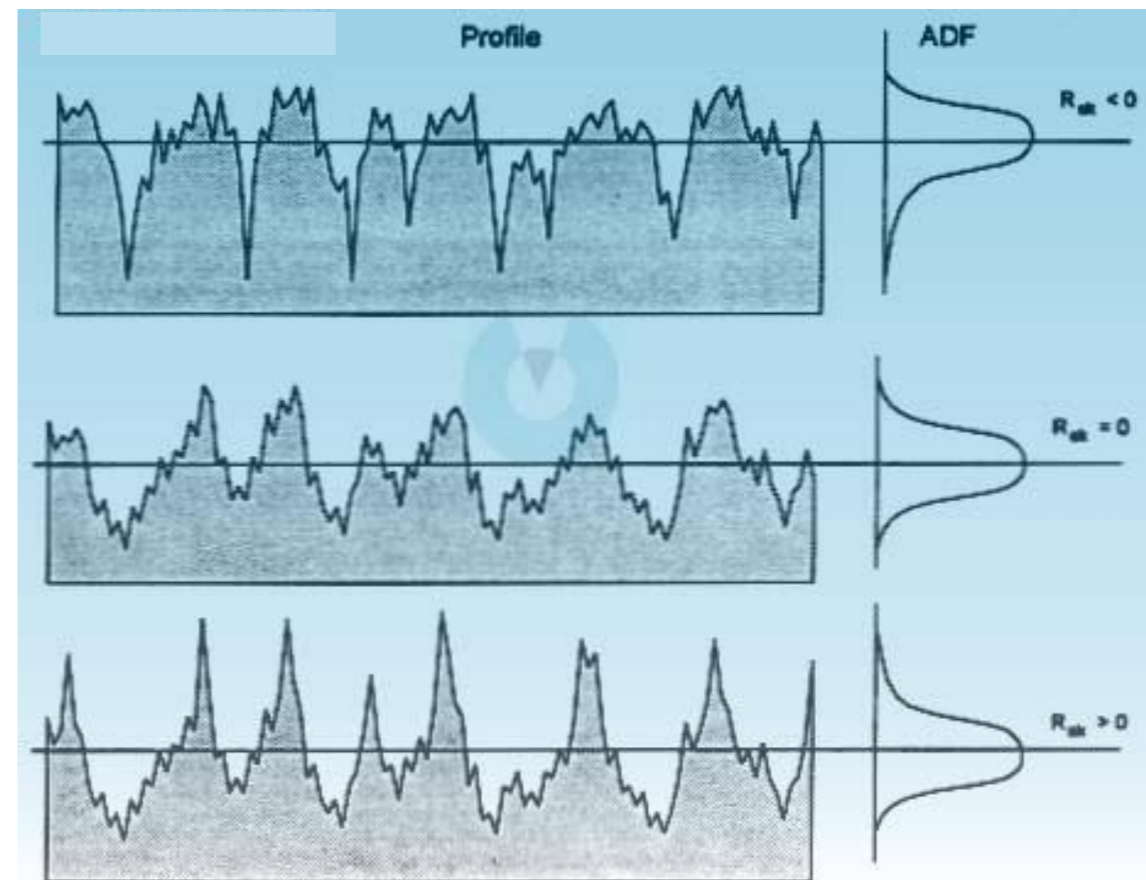

$$R_{sk} = \frac{1}{NR_q^3} \sum_{x=1}^N Z_x^3$$

Profile parameters - Statistical

Kurtosis (fourth moment of ADF)

- Kurtosis is the last ADF shape parameter considered
- It relates to the uniformity of ADF or, the spikiness of the profile
- It is non dimensional
- In statistics, a probability distribution can be constructed from all its moments
- The more moments are known, the more precisely the shape of the distribution is known.

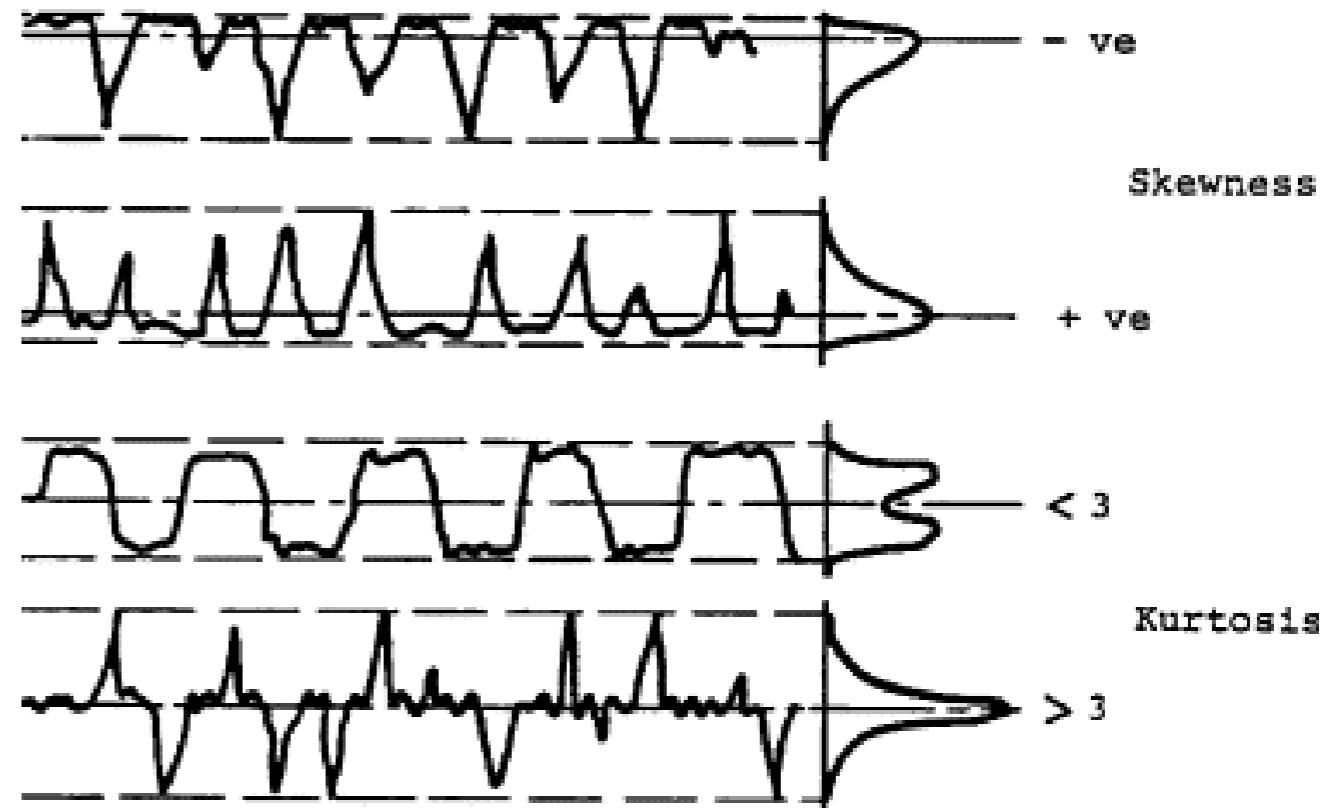

$$R_{ku} = \frac{1}{NR_q^4} \sum_{x=1}^N Z_x^4$$

Profile parameters - Statistical

(a) Grinding profile

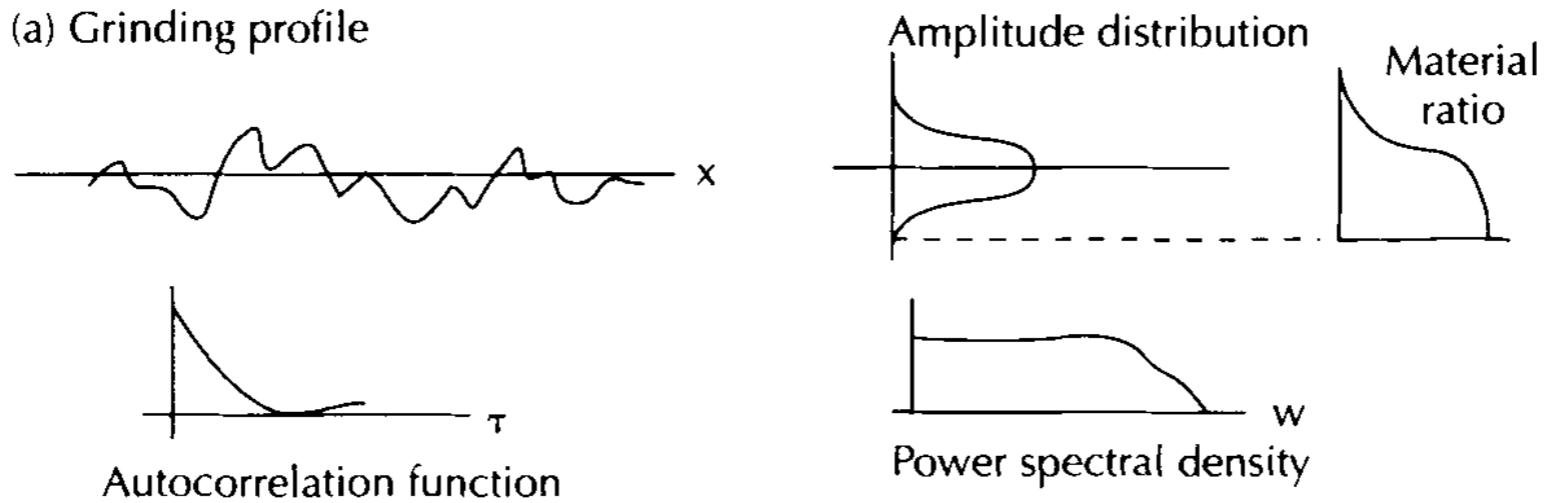

(b)

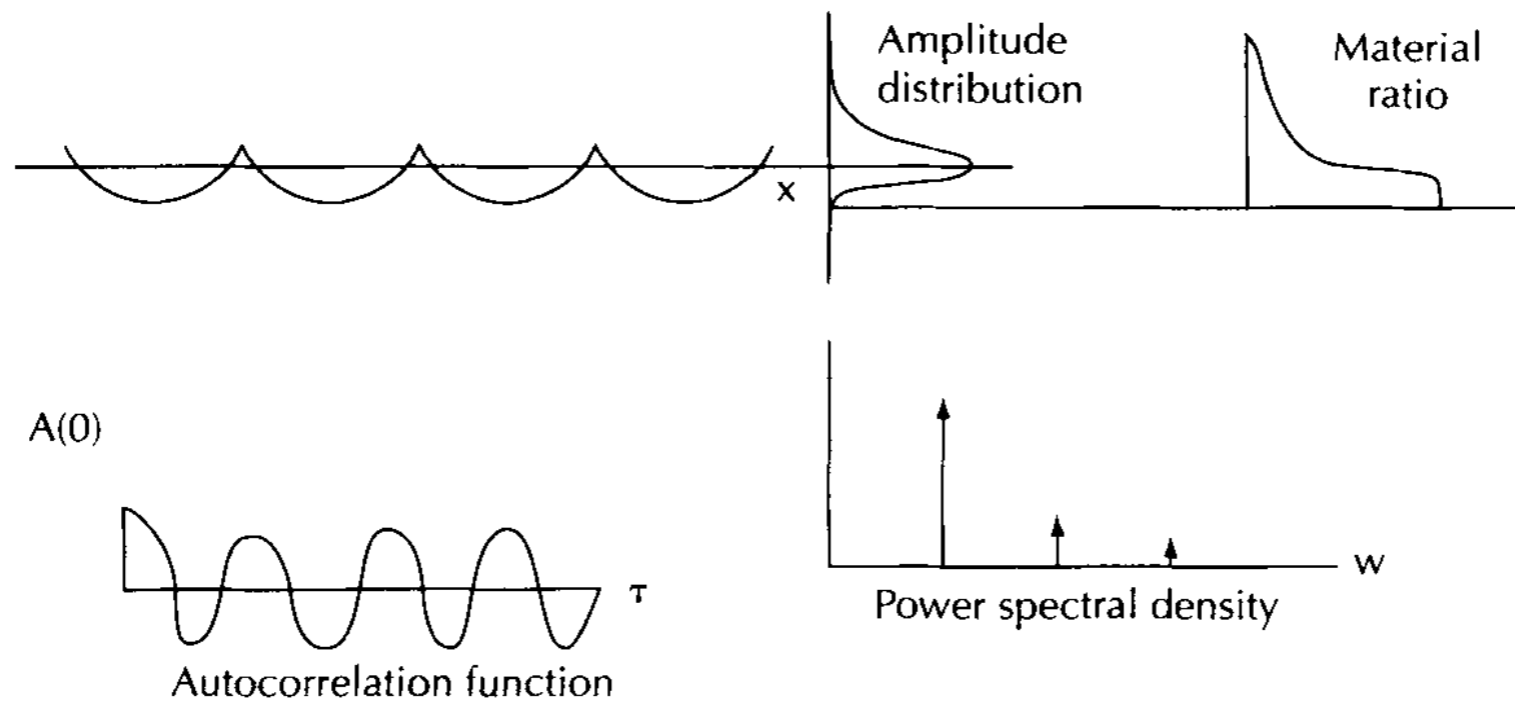

Surface metrology and manufacture

- A conventional track across the surface yields very little, as can be seen on the right of the illustration.
- **Ideally, the instrument stylus must mimic the tool path.**
- Deviations from the tool path detected by the stylus point to errors in the machine.

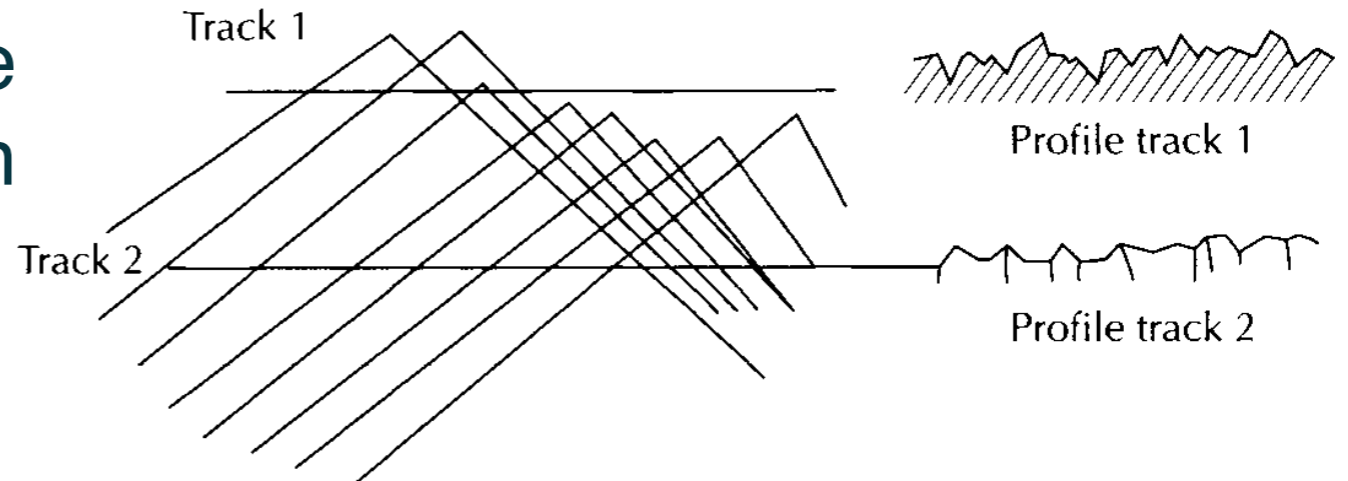

Complex lay pattern milling

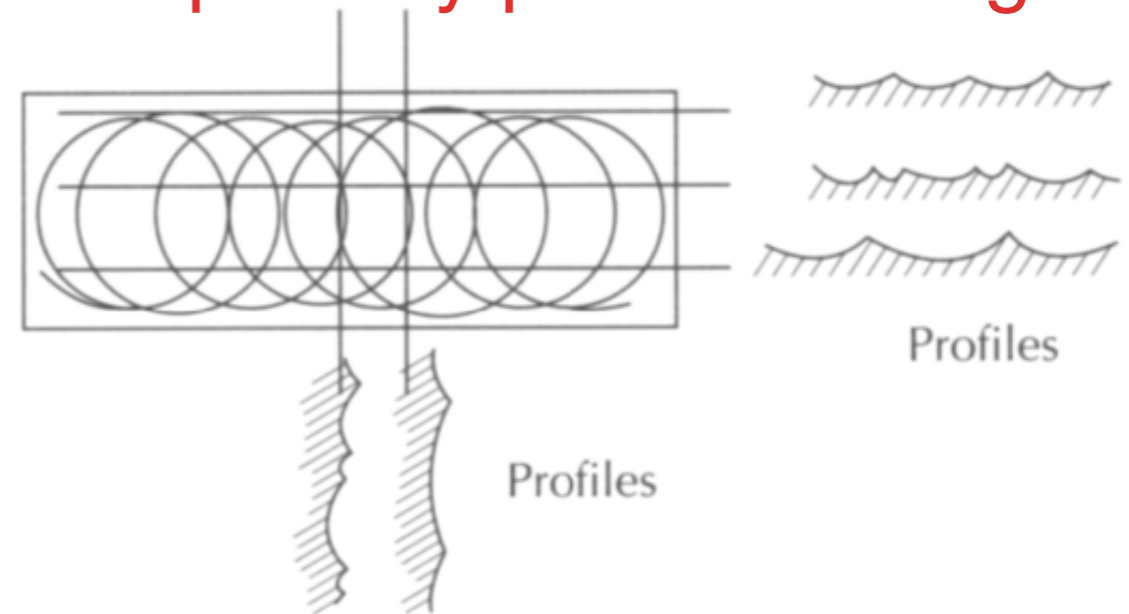

Surface metrology and manufacture

- (a) shows a profile of good turning produced by a good tool.
- As the tool wears, the ratio of the harmonic amplitudes to that of the fundamental increases (c).
- This is due to the imposition on the surface of the wear scars on the tool.
- Also on this right hand side of the fundamental spectrum, the base line can rise, due to random effects of the chip formation and micro-fracture of the surface.

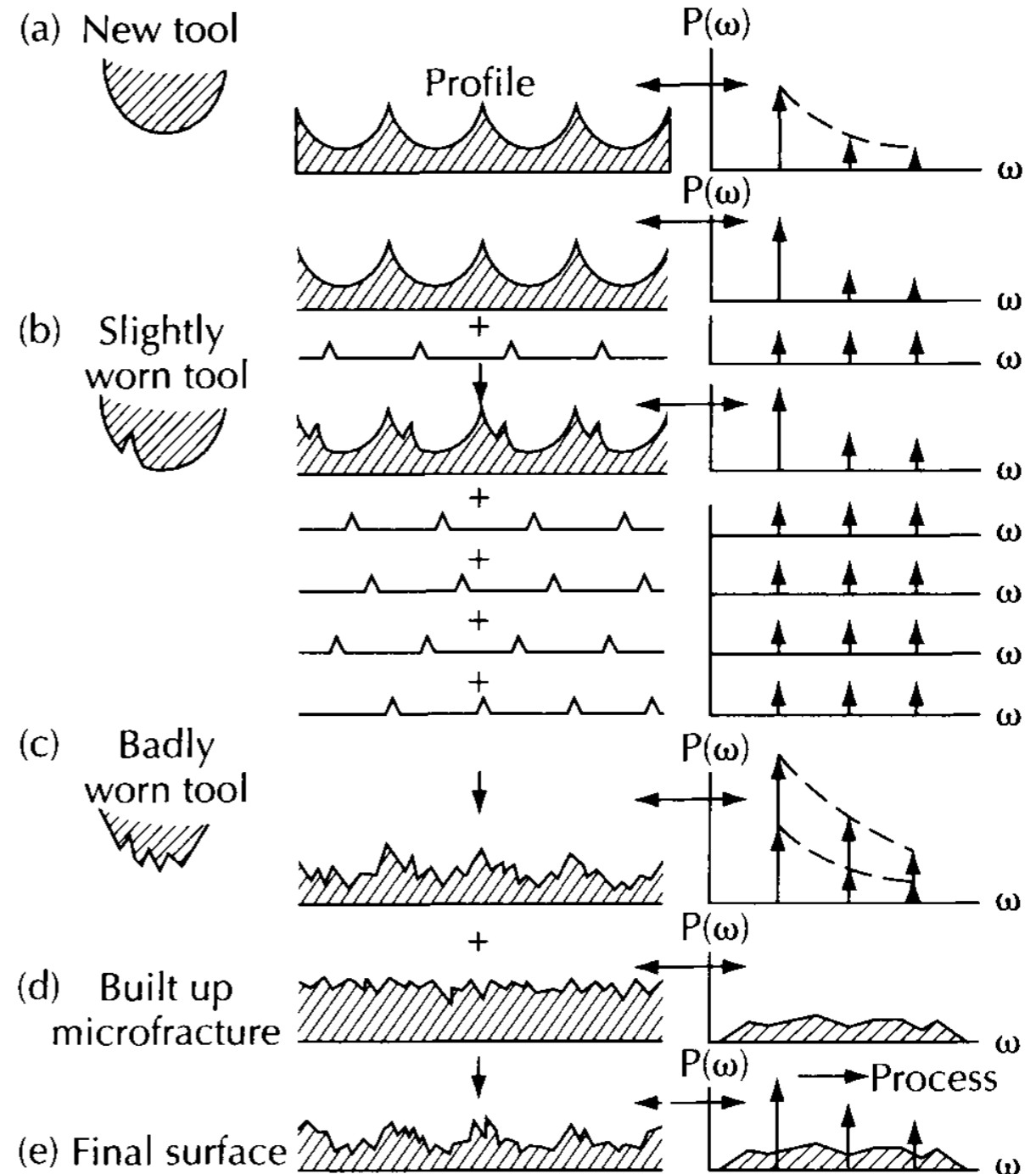

Surface topography – measurement techniques

Method	Magnification range		Resolution at maximum magnification (microns)		Depth of field (microns)		Comments
	At lowest	At highest	Horizontal	vertical	Lowest	Highest	
Optical Microscopy	X 20	X 1000	0.5	0.01* 0.03+	5	0.5	* Using interference contrast + Using Taper section
Scanning Electron Microscopy (SEM)	X 20	X 100000	0.015	1*	1000	0.2	Operates in vacuum; limits on specimen size
Transmission Electron Microscopy (TEM)	X 2000	X 200000	0.0005	0.0005	5	0.1	Operates in vacuum; requires replication of surface
Surface Profilometry	X 50	X 100000	5*	0.05	1	0.5	Operates along linear track. * Limited by stylus radius

Surface Measurement Methods

- The earliest ways of measuring surfaces
 - Thumbnail
 - Eye
- Both of these are highly effective but subjective.
- Demand for quantitative results led to the development of two branches of instrumentation:
 - One following the tactile example of the nail, (contact type).
 - The other mimicking the eye (non-contact type).

Surface Measurement Methods

Contact Type

- This mimics the thumbnail (Eg. CMM or Talysurf).
- A stylus tip is used for measuring the surface
- Stylus with tip size of approximately 0.1 to 10 μm traverse the surface.
- As the stylus tracks the surface peaks and valleys, its vertical motion is converted to a time varying electrical
- signal.
- The resulting data set is stored in a computer for statistical analysis.

Surface Measurement Methods

Contact Type

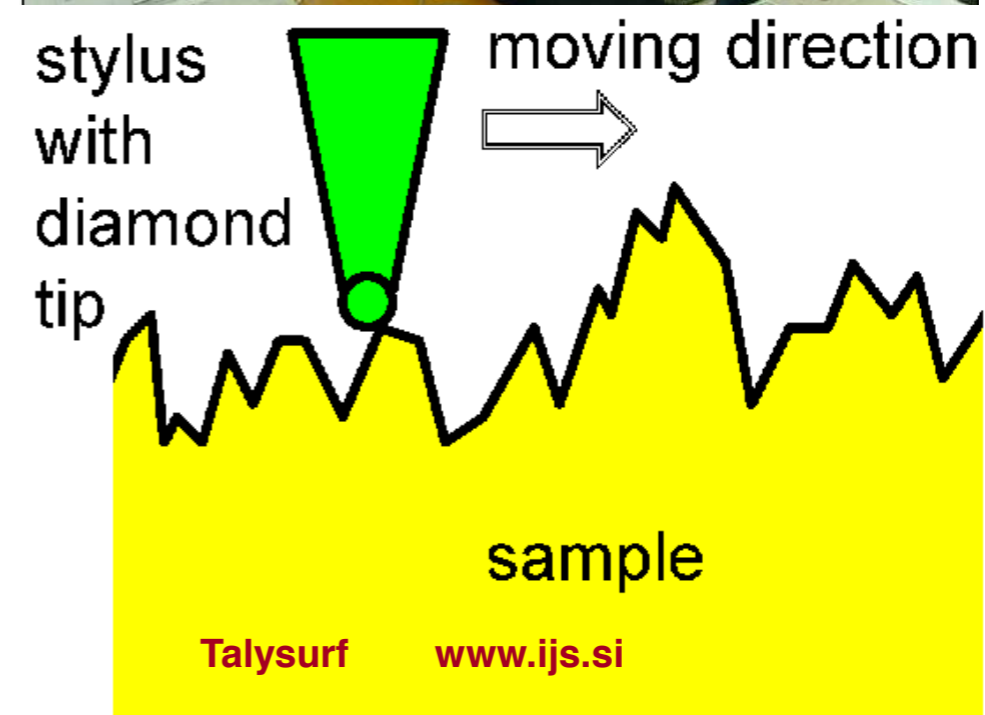
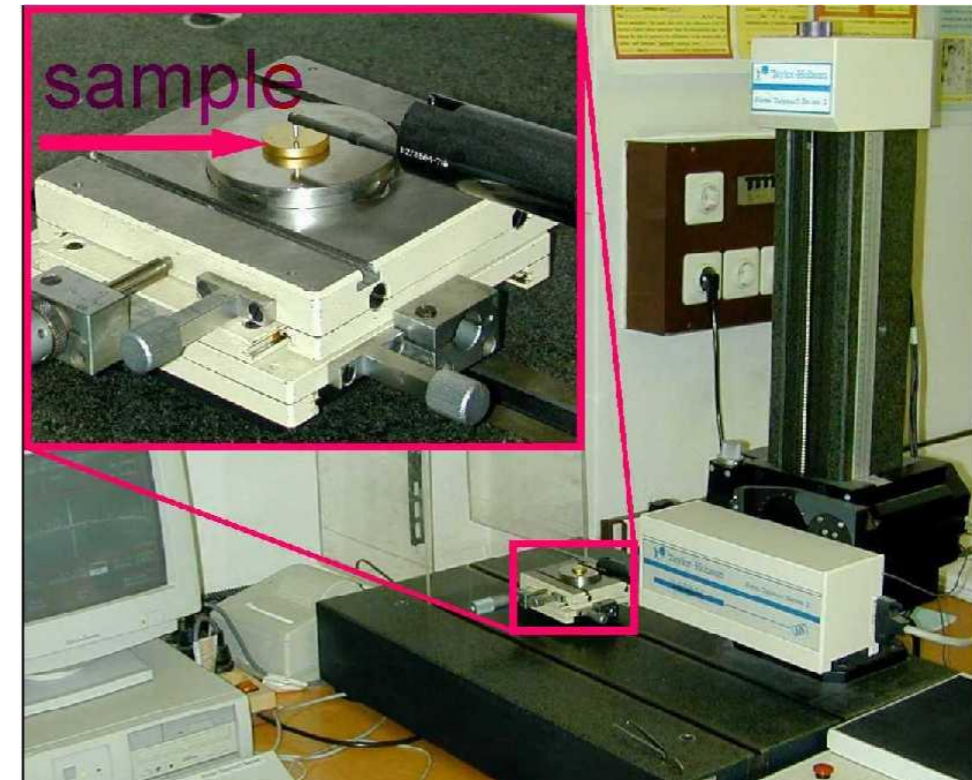
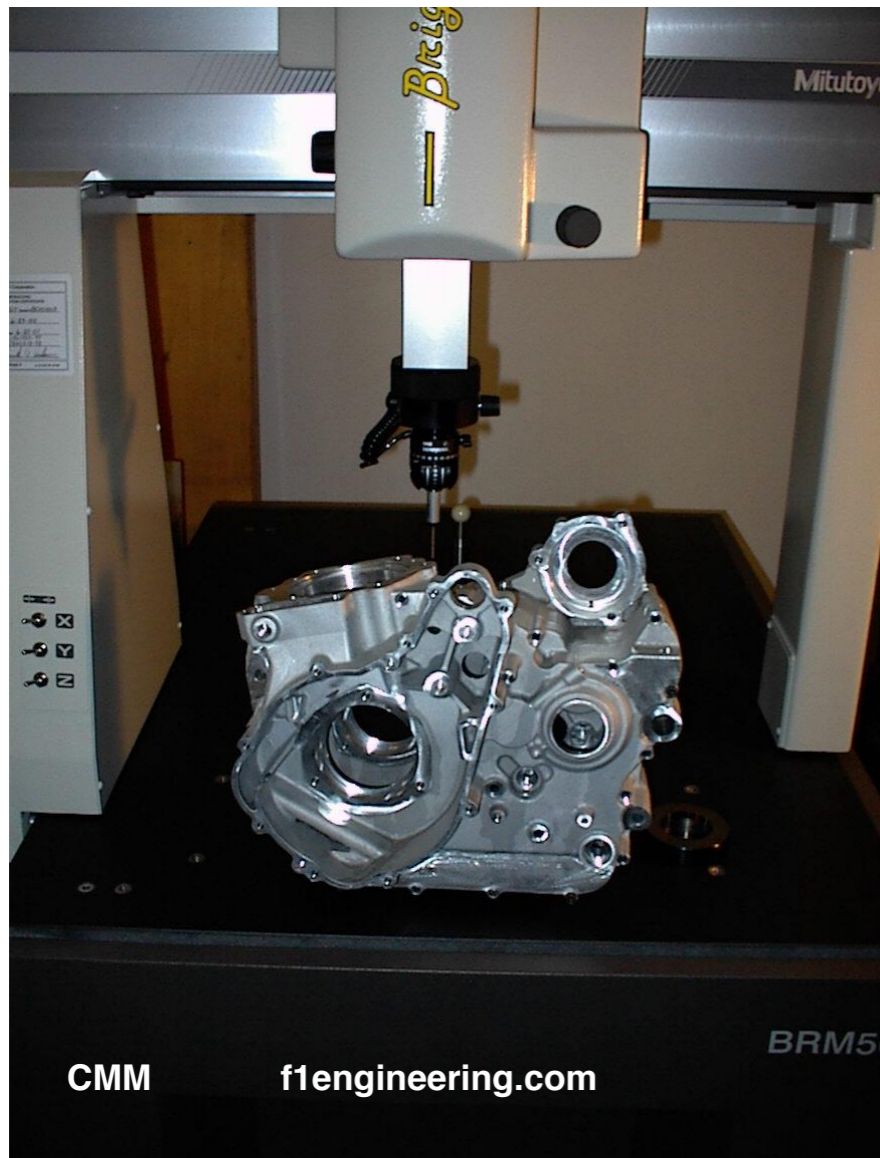

Surface Measurement Methods

Contact Type

- Stylus-based instruments have 3 reference guideways
- In this coordinate system, the stylus moves inside the measurement volume to acquire measurement data.
- The probe head moves towards the workpiece and the movement in the X, Y and Z direction are tracked by the computer.
- On contacting the workpiece, the actual coordinates are transferred to the computer.

Surface Measurement Methods

Contact Type - Disadvantages

- Scanning is time consuming
- Soft materials or bio-medical samples, which might be damaged or scratched by touch
- In process measurement is not possible.
- Limitations in resolution and accuracy due to mechanical movement and detection.

Surface Measurement Methods

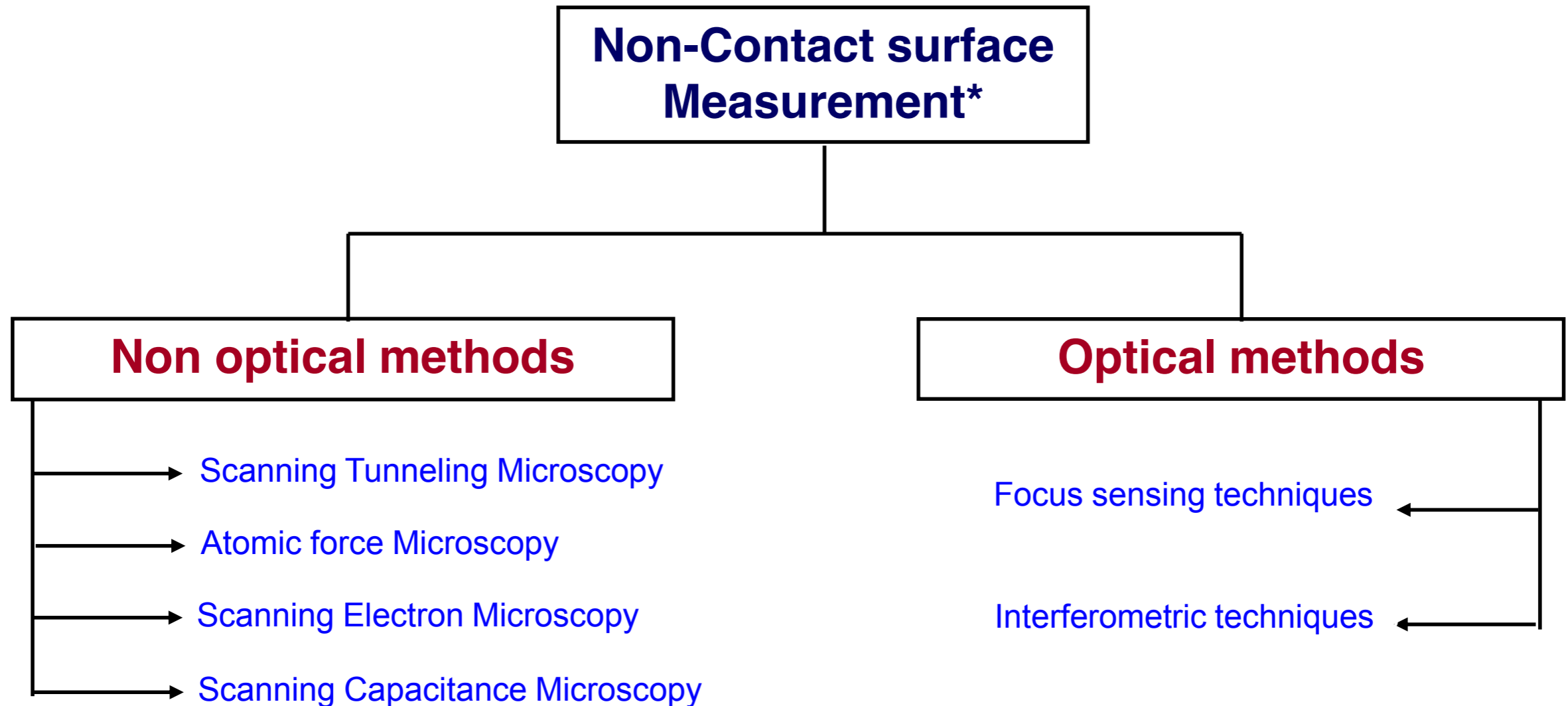

***Not Exhaustive**

STM - Introduction

- The scanning tunneling microscope (STM) is the ancestor of all scanning probe microscopes.
- It was invented in 1981 by Gerd Binnig and Heinrich Rohrer at IBM Zurich.
- Five years later they were awarded the Nobel prize in physics for its invention.
- The STM was the first instrument to generate real-space images of surfaces with atomic resolution.

Scanning Tunneling Microscopy

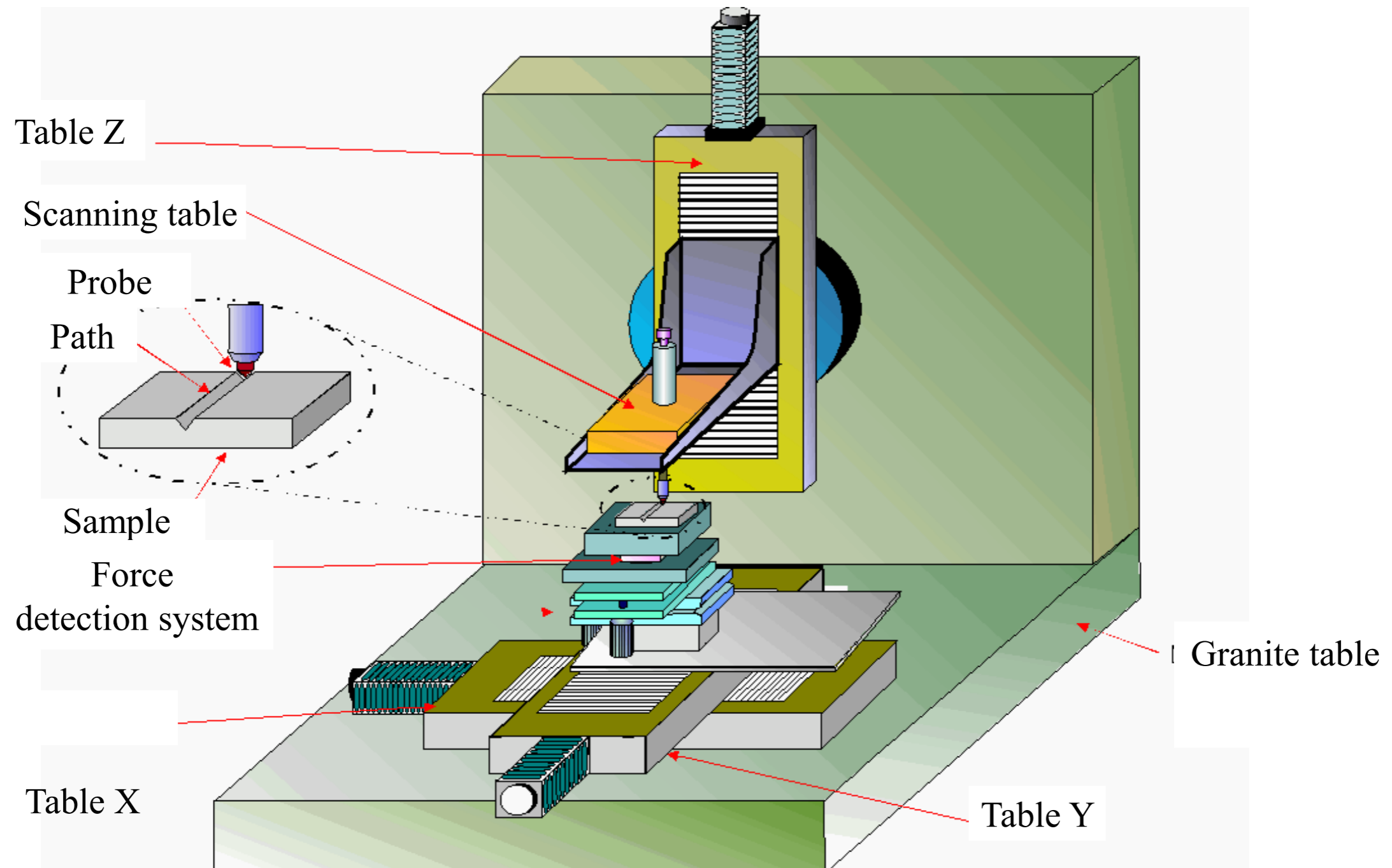

STM - Working Principle

- A sharp tip is moved over the surface and a voltage is applied between probe and the surface
- Depending on the voltage electrons will "tunnel" resulting in a weak current proportional to the distance between probe and the surface.
- A feedback loop keeps the tunneling current constant by adjusting the distance between the tip and the surface (constant current mode).
- By scanning the tip over the surface and measuring the height, surface structure of the material under study can be constructed.
- The material should be a conductor for this principle.

STM - Working Principle

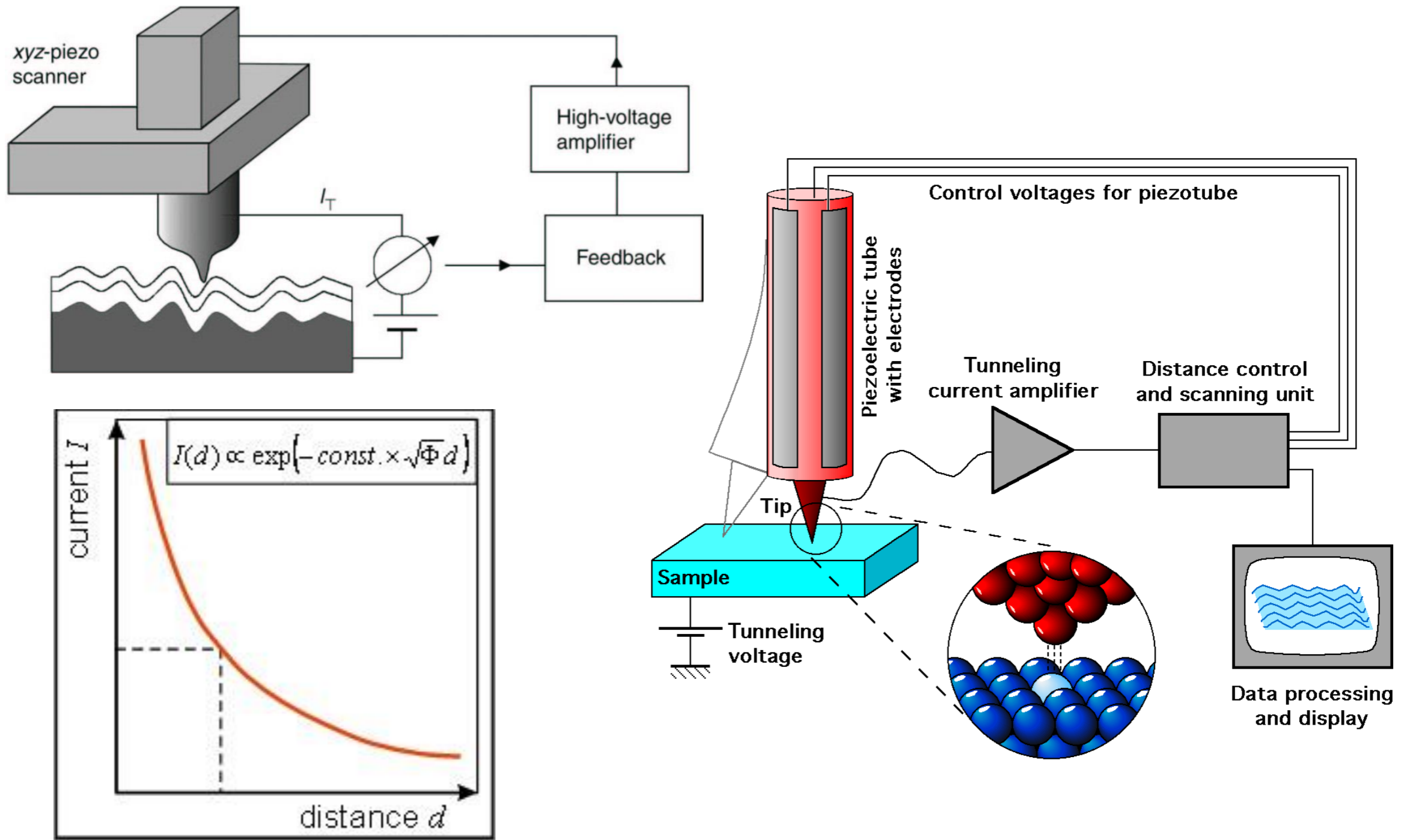

AFM - Introduction

- The second SPM, developed soon after the STM in 1986, is the Atomic Force Microscope (AFM).
- AFM tip 2μ long and $< 100\text{\AA}$ in dia located at the free end of a cantilever that is 100 to 200 μm long gently touches the surface.
- AFM measures contours of constant attractive or repulsive force
- The force is an interatomic force (van der Waals force).
- Can also be used on non-conductive materials.

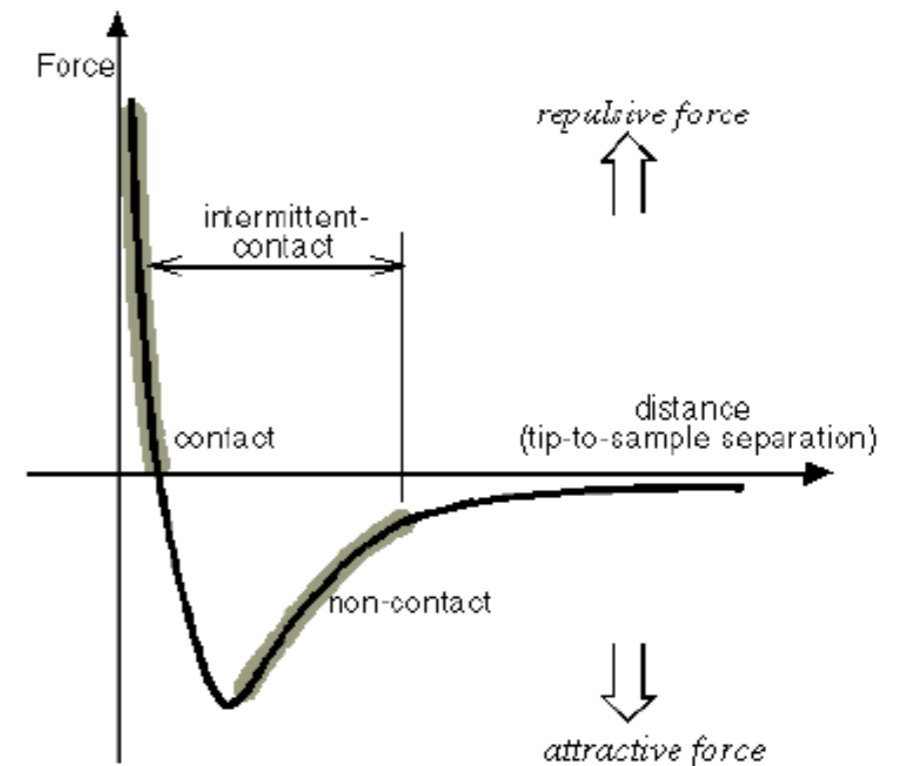

AFM - Working Principle

- Due to the topography of the probed sample and/or due to attractive or repulsive forces between the sample surface and the tip, the cantilever is bent up and down during scanning
- The bending motion of the cantilever is detected by a laser beam reflected from the cantilever to a position-sensitive light detector.
- The detection is made so sensitive that the forces that can be detected can be as small as a few piconN
- Forces < 1 nanoN are usually sufficiently low to avoid damage to surface or tip

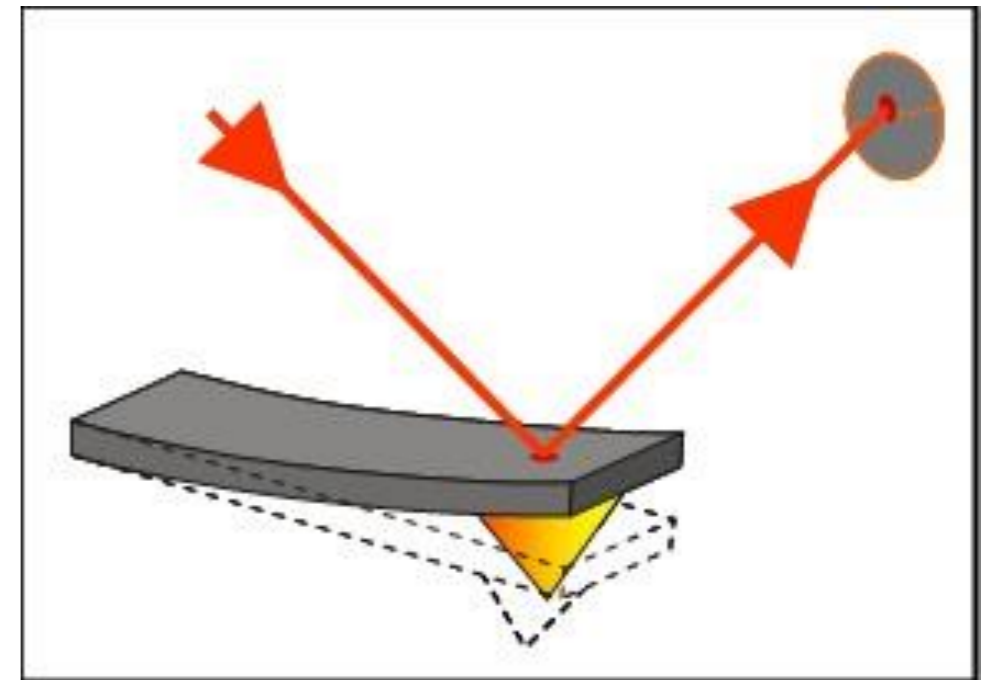

AFM - Working Principle

- In **contact mode**, tip lightly touches the sample. AFM measures repulsion forces between tip and sample
- As a raster-scan drags the tip over the sample, detection apparatus measures the vertical deflection of the cantilever, which indicates the local sample height.
- In **non contact mode**, derives topographic images from measuring attractive forces and does not touch the sample.
- AFMs can achieve a resolution of 10 pm.

AFM - Working Principle

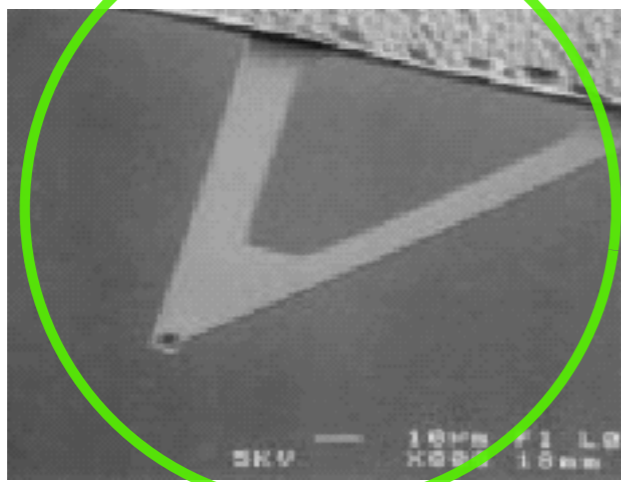
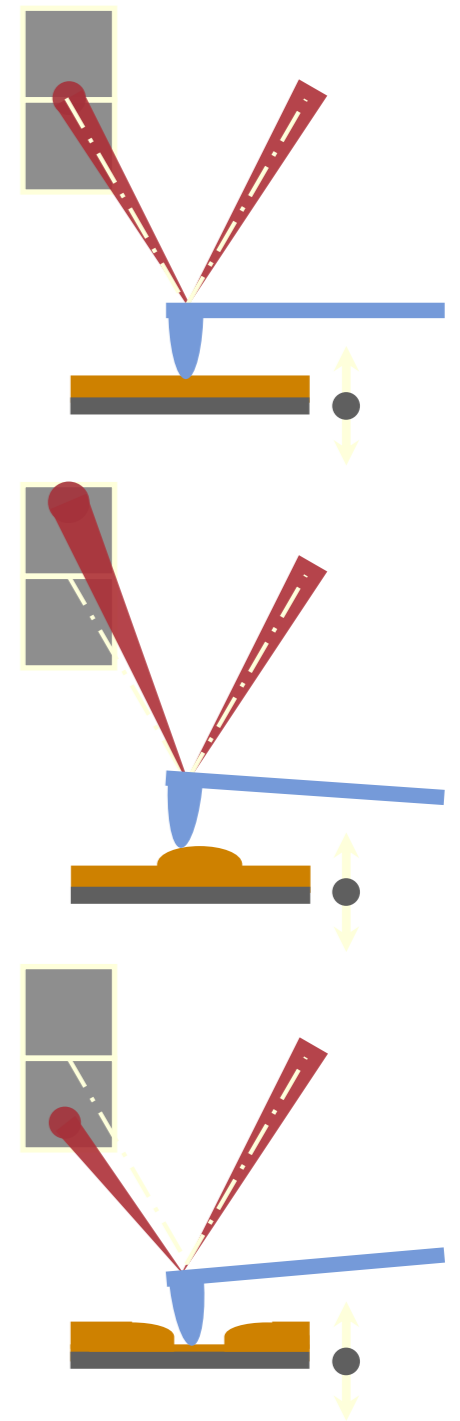
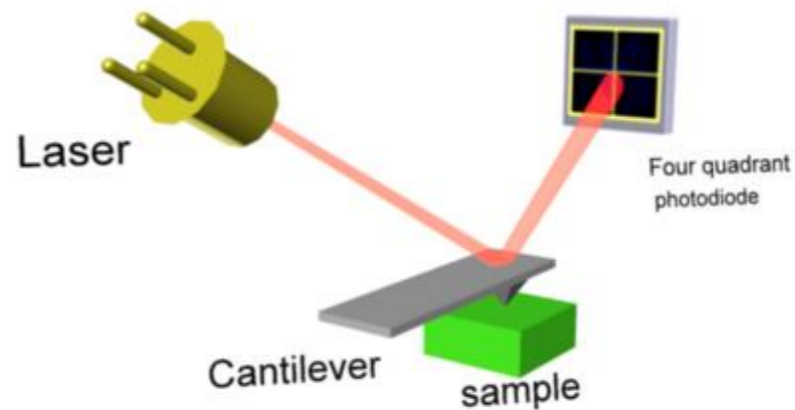
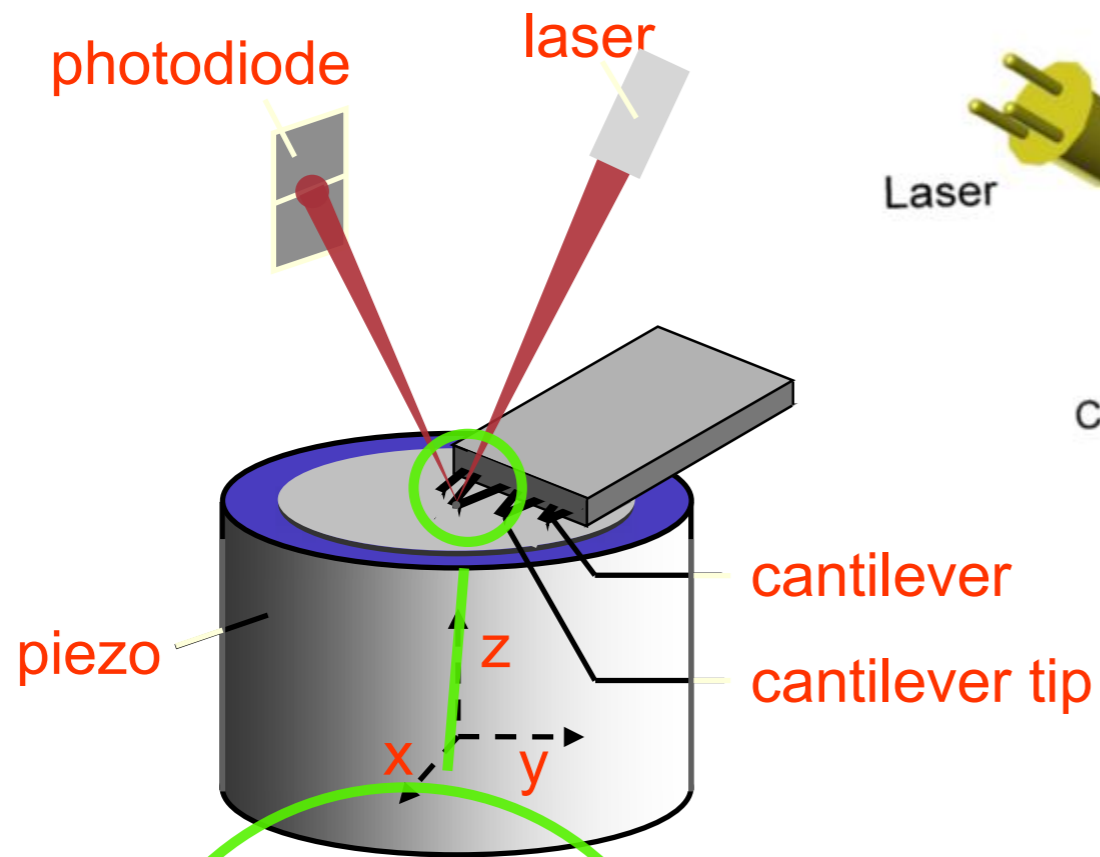

Seeing the nano world (SEM)

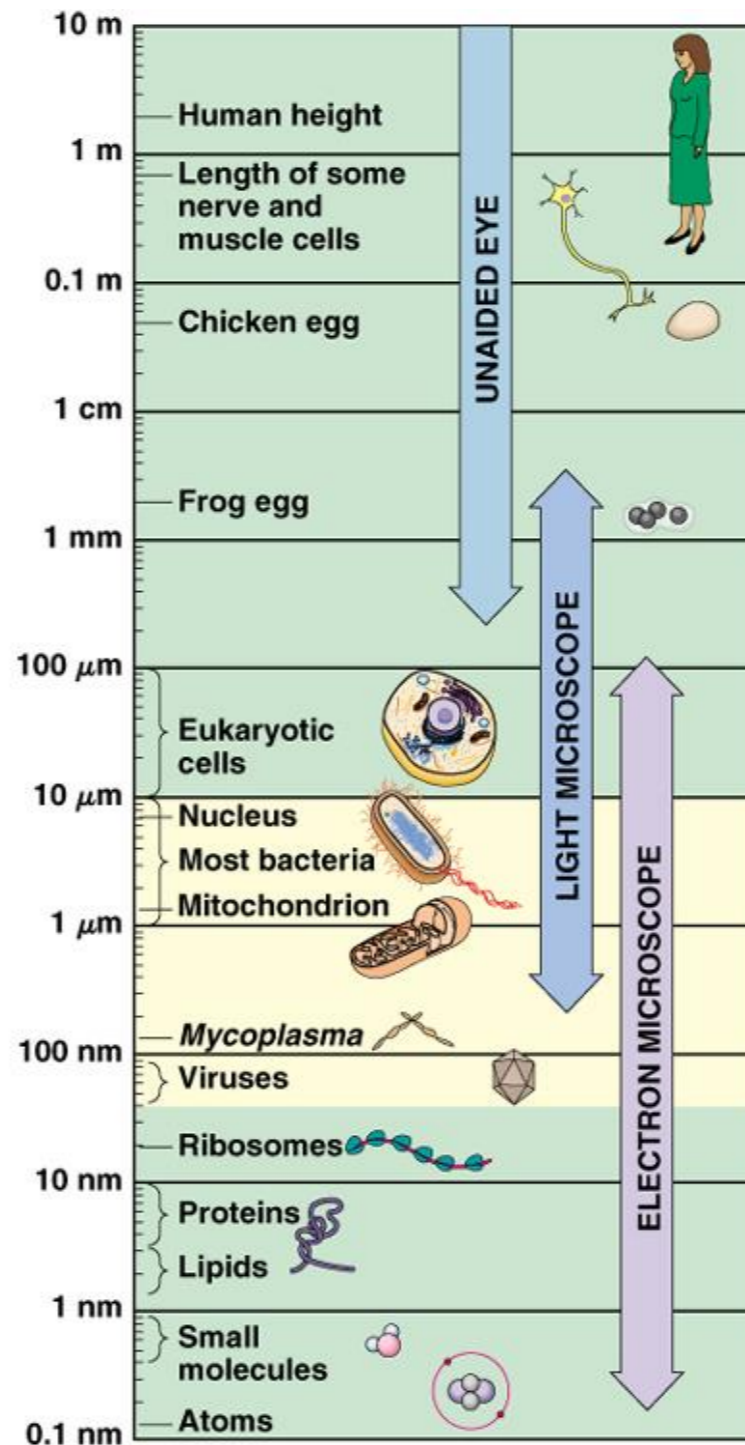

Seeing the nano world (SEM)

- Because visible light has wavelengths that are hundreds of nanometers long we can not use optical microscopes to see into the nano world. Atoms are like boats on a sea compared to light waves.

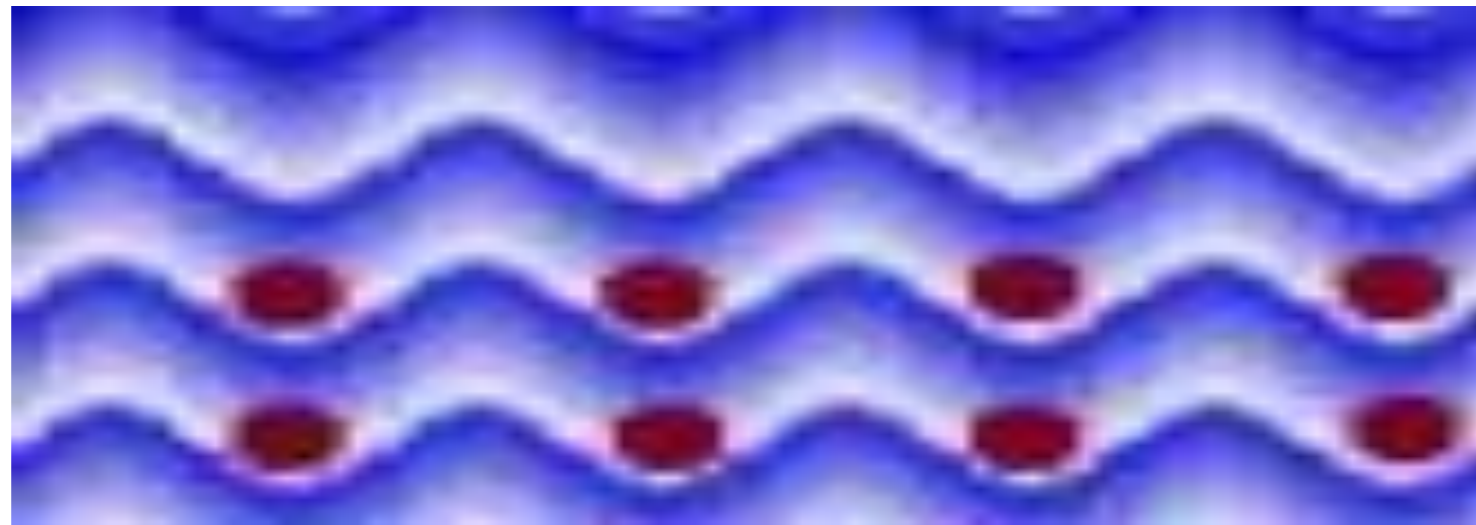

SEM - Introduction

- The first electron microscope was produced by Max Knoll and Ernst Ruska in the 1930's.
- There are many types of electron microscopes. These include:
 - TEM transmission electron microscope.
 - SEM scanning electron microscope.
- Enhanced depth of field
- Much higher resolution (up to 10^{-6} μm).

Scanning Electron Microscope

- In SEM, electrons are accelerated in a vacuum until their wavelength is extremely short. The higher the voltage the shorter the wavelengths
- Beams of fast-moving electrons are focused on an object and are absorbed or scattered by the object so as to form an image on an electron-sensitive photographic plate
- SEM samples have to be electrically conductive and not produce vapors in a vacuum

SEM - Overview

- Topography
 - The surface features of an object or "how it looks", its texture.
- Morphology
 - The shape, size and arrangement of the particles making up the object that are lying on the sample surface.
- Composition
 - The elements and compounds the sample is composed of.
- Crystallographic Information
 - The arrangement of atoms in the specimen

SEM - Working Principle

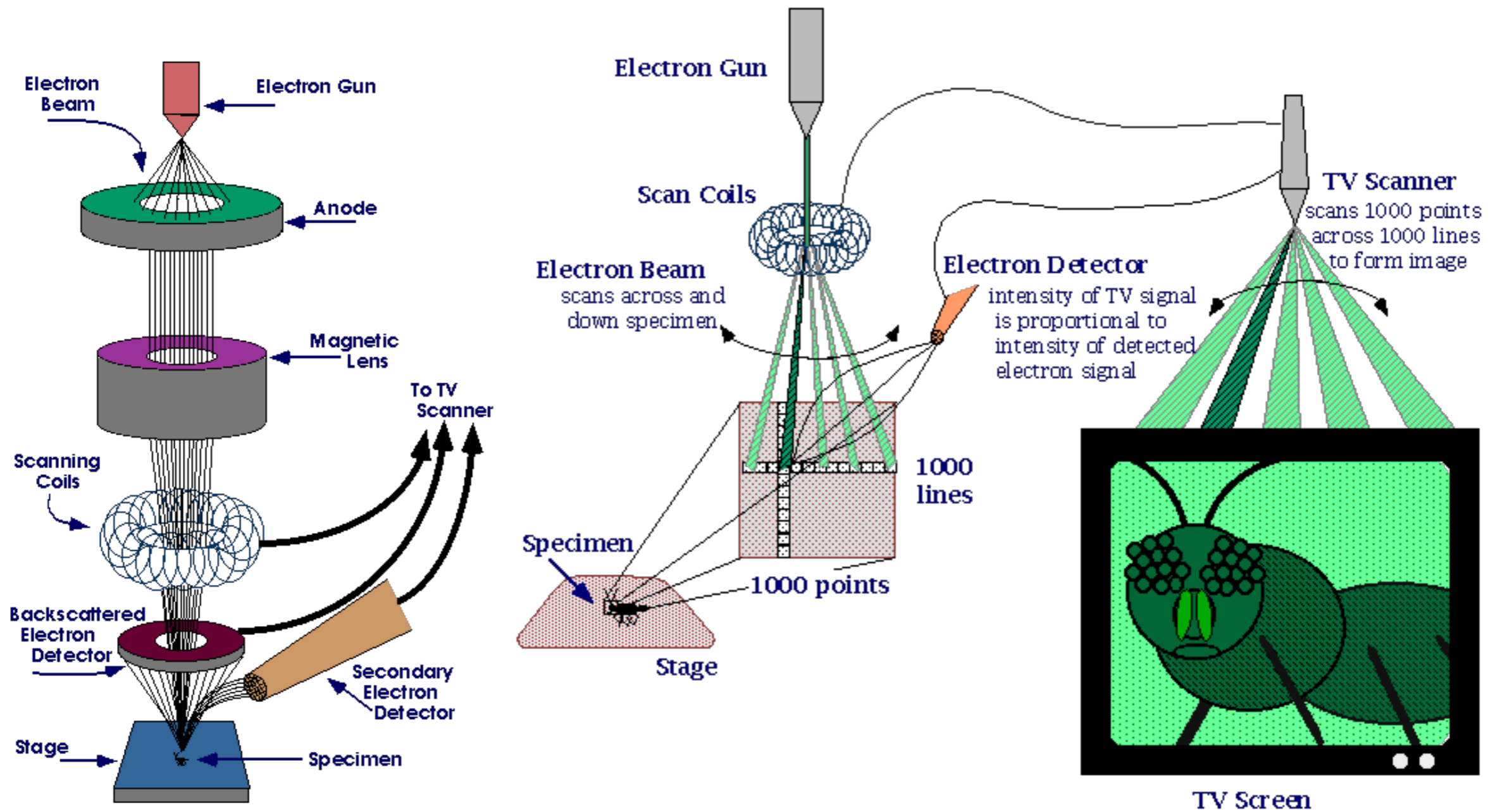

SEM - Working Principle

SEM Setup

Electron/Specimen Interactions

When the electron beam strikes the sample, both **photon** and **electron** signals are emitted.

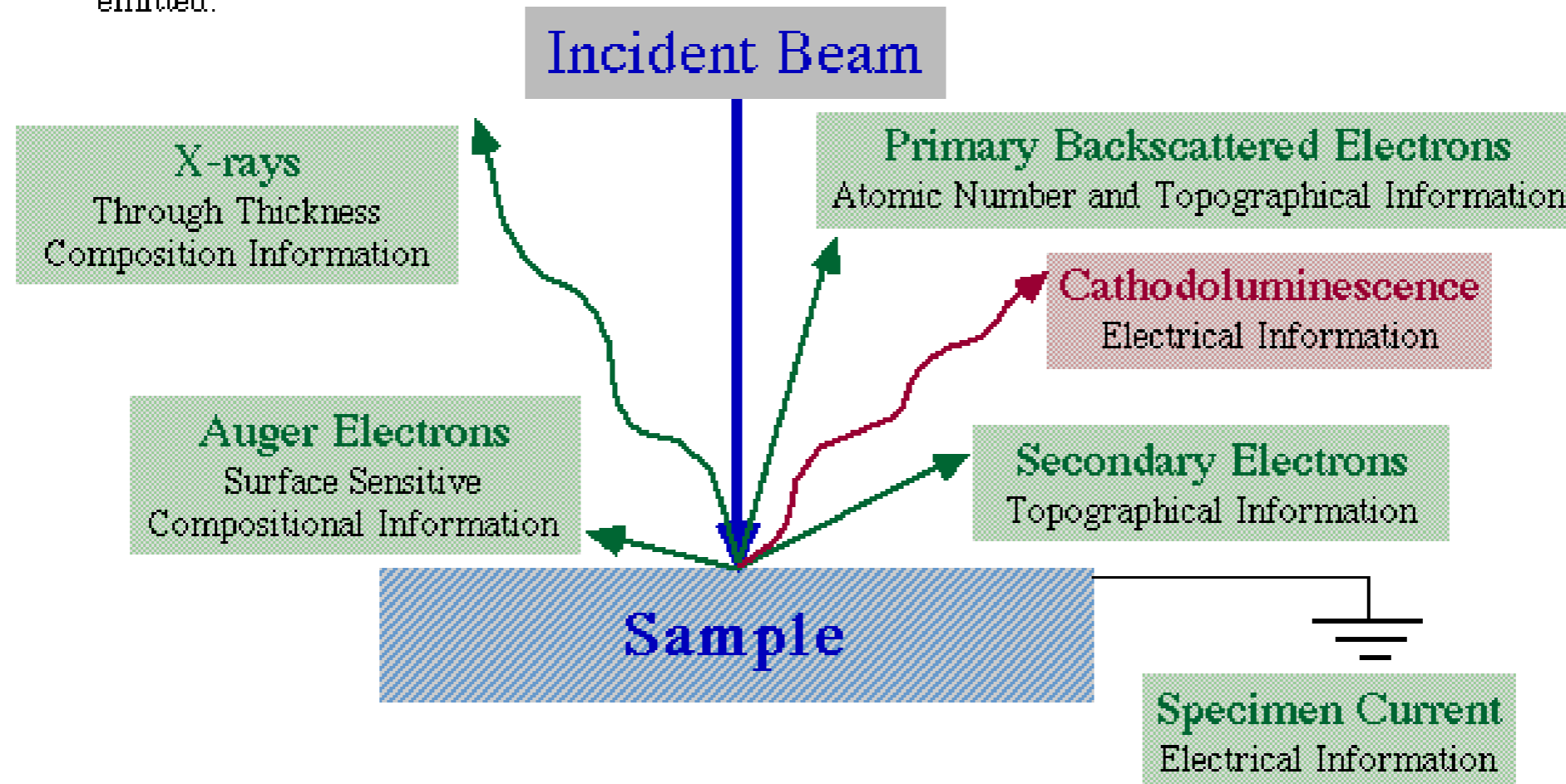

TEM - Working Principle

- The first TEM was invented in Germany in 1931. It was the first microscope that could resolve the interior structure of a cell with over 10,000 X magnification.
- TEMs can be used to look at the morphology of the sample on the atomic scale, the crystalline structure of the sample, and in some cases the elemental composition of the sample.

TEM - Working Principle

- TEM works like a slide projector. Focused electron beam is sent on a very thin specimen; the specimen deflects and scatters the beam which is projected on a screen
- Requires stringent preparation sample to be thin for electrons to pass through and the sample must withstand high energy electrons & a strong vacuum

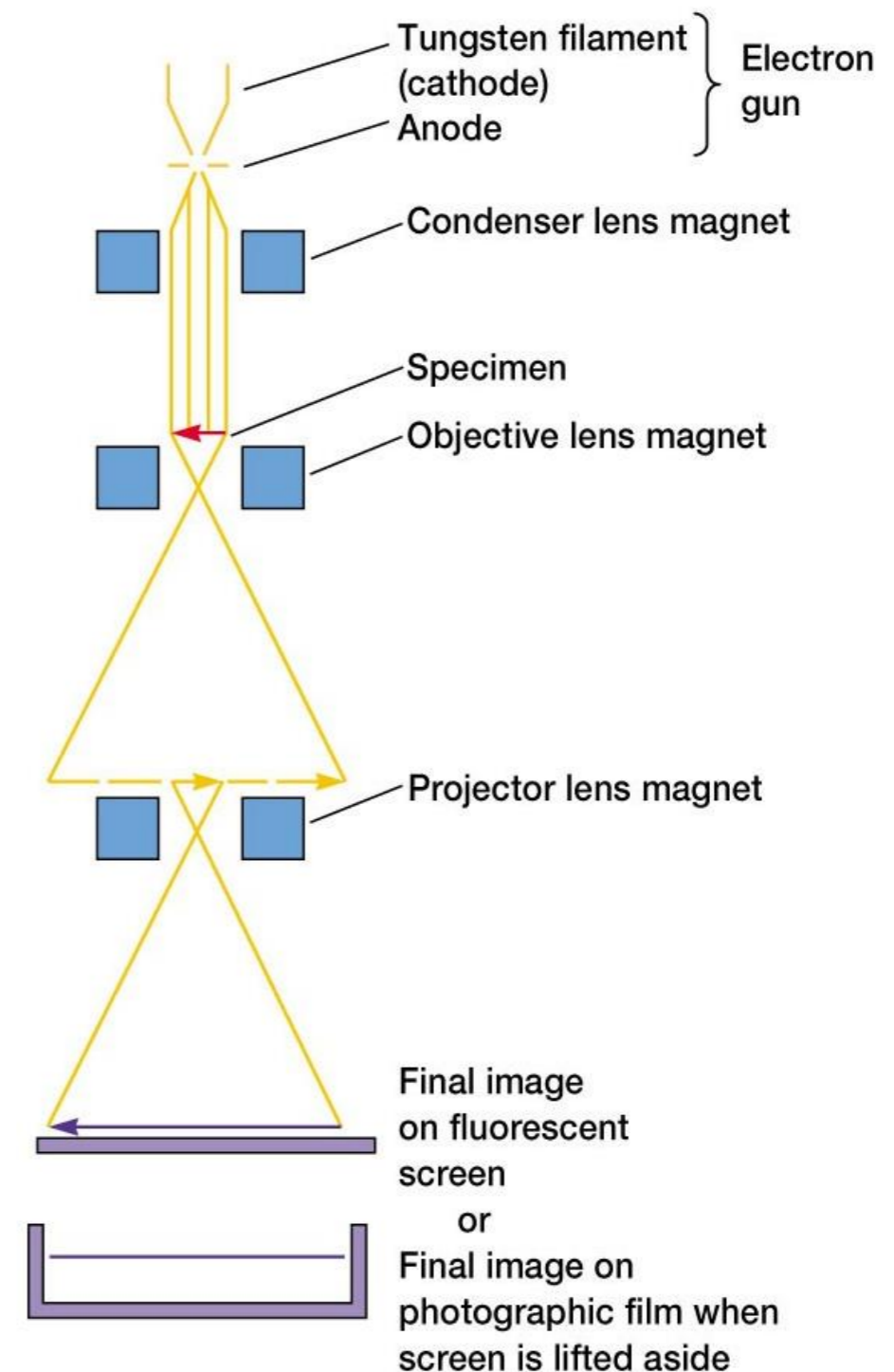

SEM - Applications

- Imaging of microscopic scale objects in high resolution
- Medical: compare healthy and unhealthy cells.
- Forensics: compare hair, fibers,, paint, inks, etc.
- Metals: structural strength.
- Scientific Research: cells, nanotubes, metals. Etc.

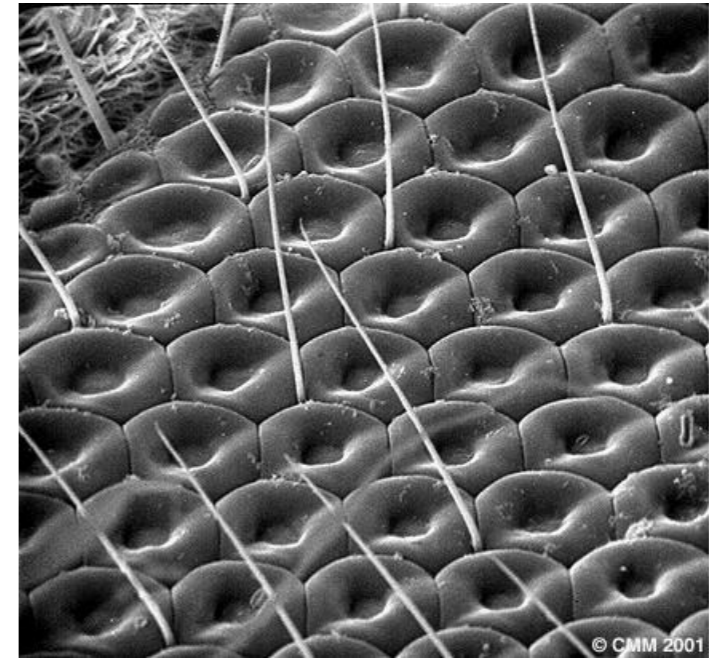
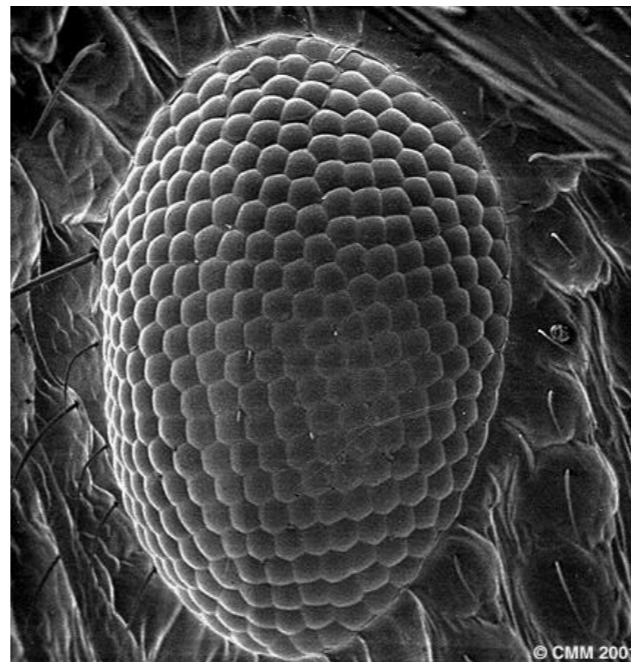
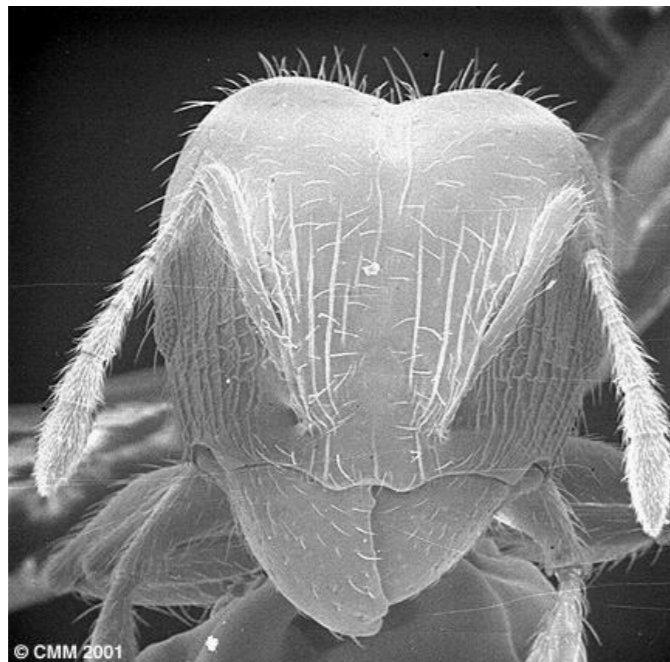

Surface Measurement

Optical Methods

- light is refracted (bent) when passing from one medium to another
- refractive index
 - a measure of how greatly a substance slows the velocity of light
- direction and magnitude of bending is determined by the refractive indexes of the two media forming the interface

Surface Measurement

Optical Methods

- Lenses focus light rays at focal point
- distance between center of lens and focal point is Focal Length FL
 - shorter focal length \Rightarrow more magnification
- In microscopes, a magnified image is formed by action of ≥ 2 lenses

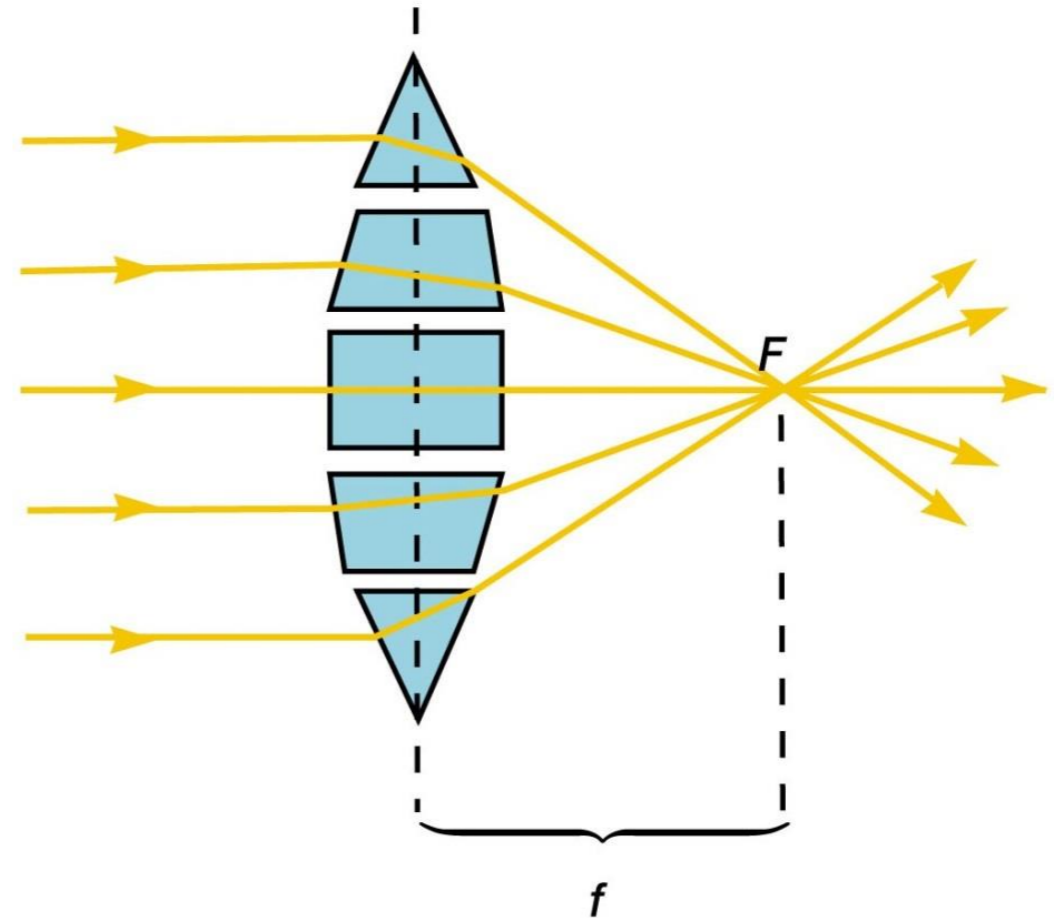

The Microscope

- Many types
 - bright-field microscope; dark-field microscope
 - phase-contrast microscope; fluorescence microscopes
- Ability of a lens to separate or distinguish small objects that are close together
- Wavelength of light used is major factor in **resolution**
 - shorter wavelength \Rightarrow greater resolution
- Distance between the front surface of lens and surface of cover glass or specimen is the **working distance**

The Light Microscope

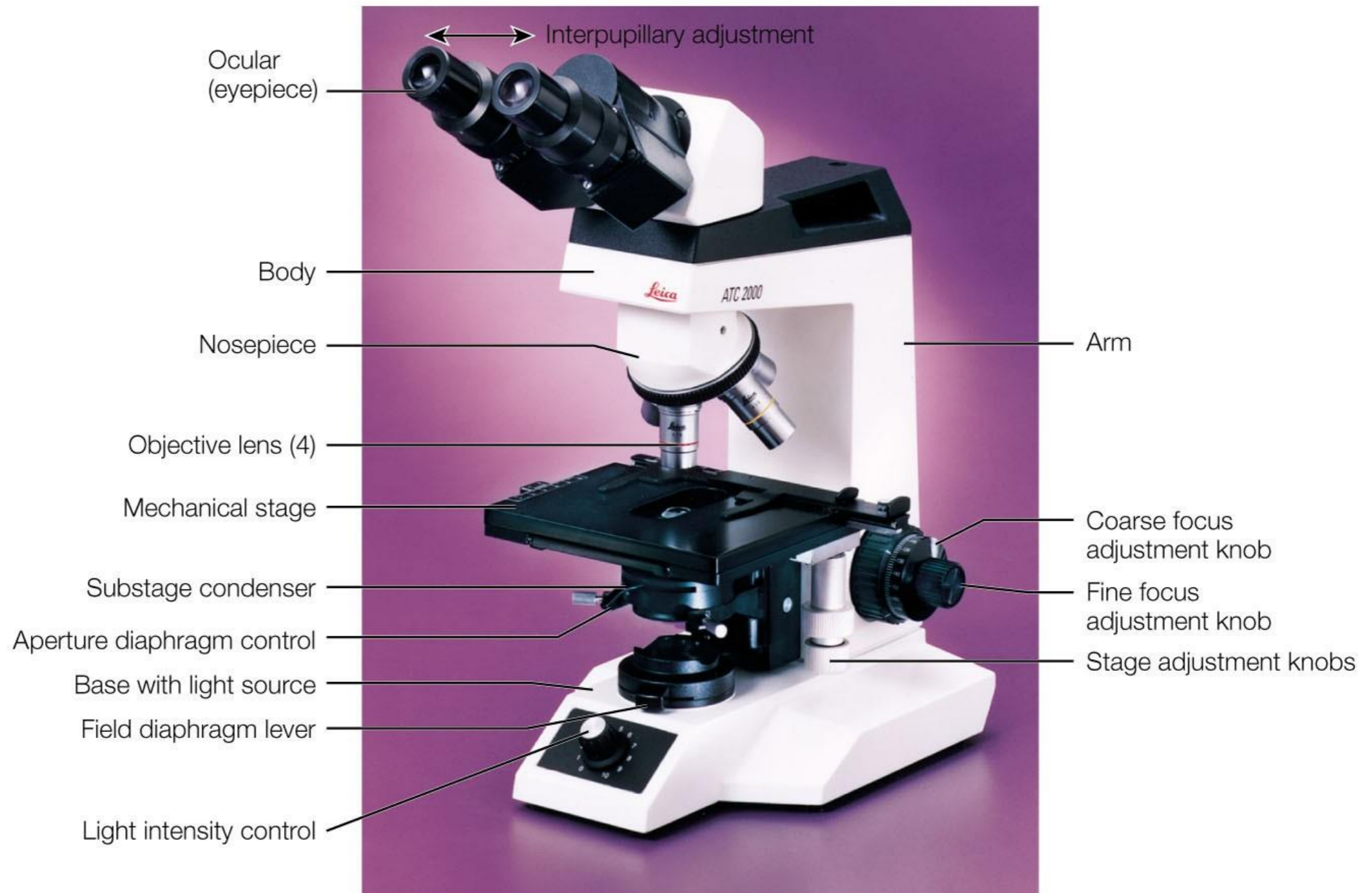

Confocal Microscopy

- Ordinary light microscope produces 2-D superposition of in-focus and out-of-focus regions
- Tracing only focused parts of photographs at different focus settings difficult for specimens lacking clear borderlines
- Slicing specimen into large number of thin sections is time-consuming and may deform the specimen; cannot study living specimens this way and alignment of images of different slices requires considerable computer processing
- In Confocal microscopy, a Laser beam illuminates spots on specimen
- Computer compiles images created from each point to generate a 3-dimensional image

Optical Principles

- Specimen illuminated one point at a time
- Detector only registers light from illuminated point
- Resolution limit is improved
- Very pronounced depth discrimination is obtained
- Can study different depth layers much more clearly (no out-of-focus information in image) and can study surface structures

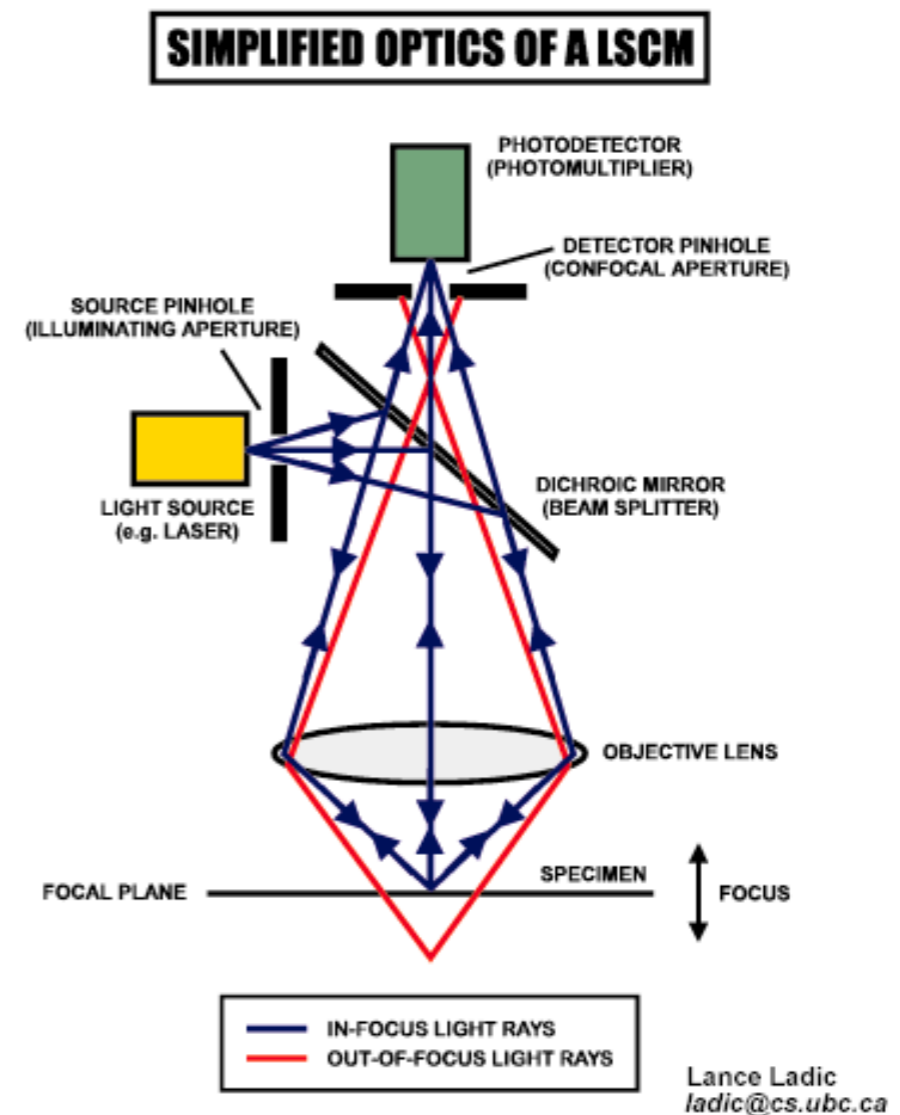

Why Confocal Microscopy?

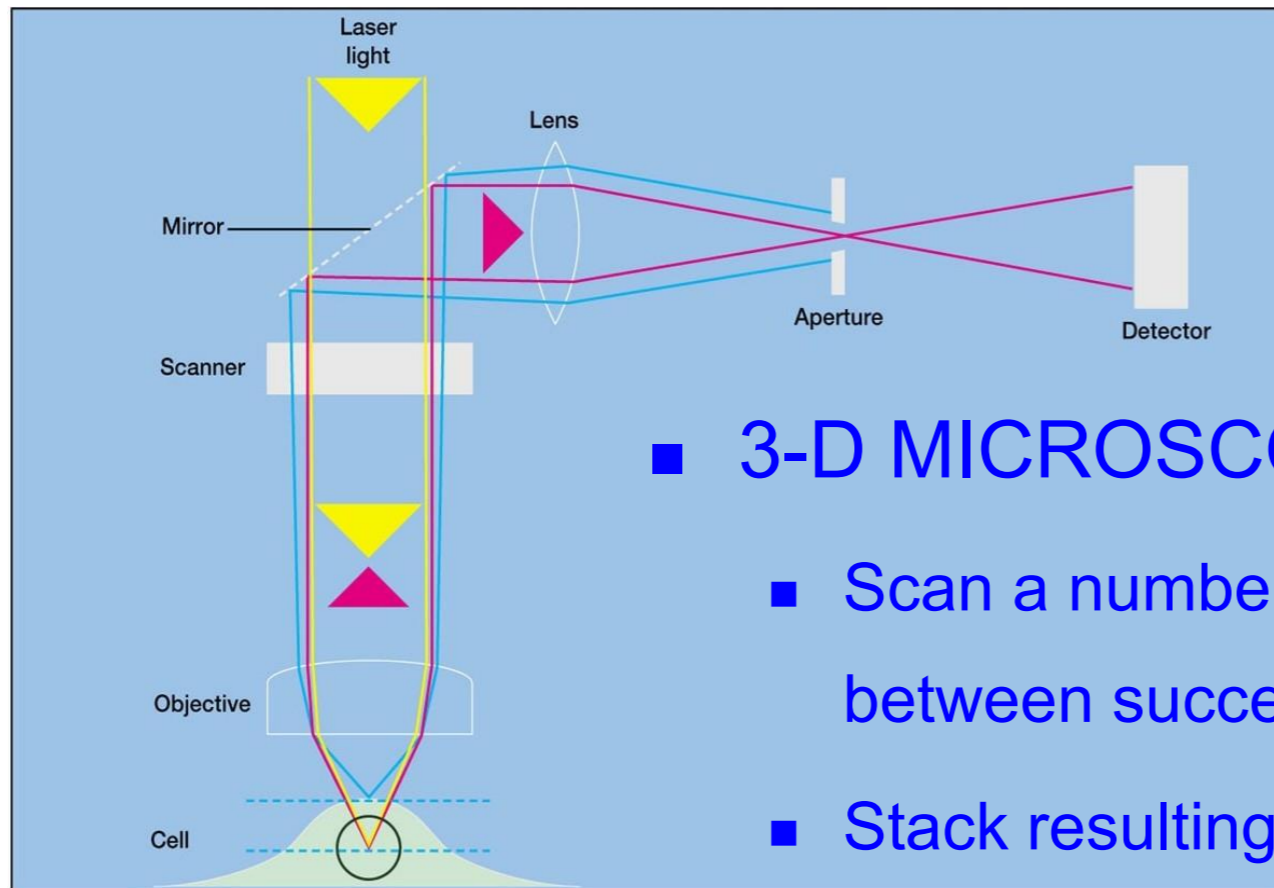

- **3-D MICROSCOPY!**

- Scan a number of confocal images, refocusing between successive images
- Stack resulting images to produce 3-D structure
- No need for alignment processing
- Can record sections of live specimens
- Can make projections of image to view from different angles

Feasibility Studies

- To successfully perform confocal microscopy, specimen must be reasonably transparent to allow light to penetrate to regions below the surface of the specimen
- Carlsson and Åslund selected three different applications for their paper: two physiological and one botanical

Feasibility Studies

- Studied various neurons in spinal cord of lamprey
- Used fluorescent confocal microscopy by staining cells with a dye
- Obtained good understanding of 3-D structure of neurons by displaying projections through recorded volume in rapid succession
- One difficulty in studying neurons is the specimen thickness (100s of μm): makes it impossible to scan deepest part of specimen using objective with large N.A.

